

MORETTIDESIGN

AIR

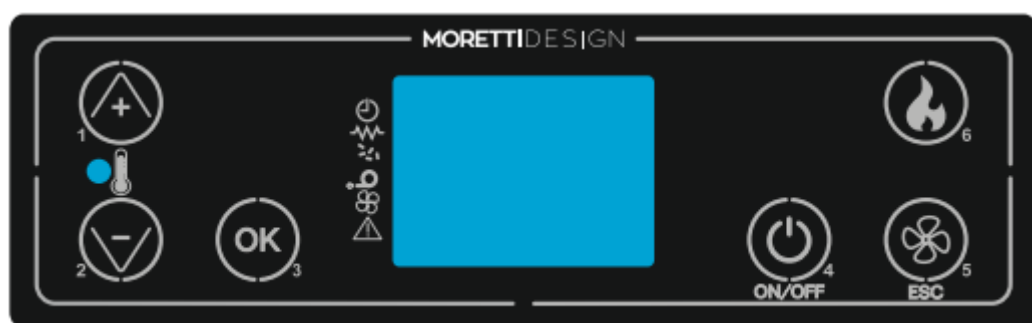

USER MANUAL

AIR STOVES

INDEX

INTRODUCTION	2	THE MENUS	12
General safety warnings	2	Eco clima	12
DESCRIPTION	2	Chrono	12
Identification	2	Time and date	13
Description of the stove	3	Language	13
INSTALLATION	3	Settings	13
Supply conditions and unpacking	3	Initial load	14
Assembling	3	Fan mode (only for C models)	14
Combustion air	3	Monitor	14
Combustion air for a hermetic installation	3	WiFi Status (optional if provided) /LED-MODE(models with led)	15
Fume exhaust	3	Calibration	15
Installation examples	3	System menu	15
Operating conditions	5	EMERGENCY CONTROL PANEL	15
Residual risks	6	DISPLAY	16
SAFETY DEVICES	6	SAFETY ALARMS	20
MINIMUM SAFETY DISTANCES	6	CONTROL UNIT- COMPACT GLASS A/C, SLOT GLASS A/C, SLOT REMOTE AIR	22
FIRST IGNITION	6	CENTRALINA ELETTRONICA - SAT GLASS A, GLOBE GLASS A/C	24
Positioning the deflector	6	CONTROL UNIT - RELAX CLEAN, COMPACT DESIGN A/C, 9, 11, 13 KW MODELS A/C CLEAN, COMPACT HYBRID	26
Pellet loading	6	CONTROL UNIT - DREAM, DOLBY	28
Ignition mode	6	CONTROL UNIT - KUBIC, BIJOUX	30
COMBUSTION	7	WI-FI NAVEL 2.0 (Optional) e NAVEL INSIDE (As standard)	32
FCS (Fire Control System)	7	MAINTENANCE	33
CONNECTION AND DESCRIPTION ON HOW A DUCTED STOVE OPERATES	7	Cleaning the burner	33
Optional	8	Automatic burner cleaner	33
Single ducted outlet (CN) stove function	8	Emptying the ash drawer	33
Double ducted outlet (DX, SX) stove function	9	Cleaning the tube bundle	33
MANUAL ADJUSTMENT OF THE HEATING FAN SPEED (RELAX MODEL)	10	Cleaning the pellet tank	33
OPENING AND CLOSING THE FRONT GLASS DOORS (COMPACT DESIGN MODEL)	10	FireWall	33
REMOTE CONTROL	11	Cleaning the surfaces	33
Introduction	11	WARRANTY CONDITIONS	33
Button description	11	Warranty certification	33
Remote control channel change	11	Warranty conditions	33
OPERATING STATUS	12	EXCLUSION OF LIABILITY	33
Ignition of the stove	12		
Stove in work mode	12		
Room temperature setting	12		
Ducted outlets temperature setting (C Models)	12		
Combustion power setting	12		
The room temperature reaches the SET temperature	12		
Turning off the stove	12		

We would like to compliment you on purchasing a MORETTI DESIGN pellet stove heater.

Our products are well advanced in the heating and granular combustion field, the advanced technology used as well as fine detailed design, render our heaters the most performing and reliable for pellet combustion. The high quality of materials used combined with skilled craftsmanship all lead to a product that meets all necessities that range from their aesthetic appearance to functional use as well as rendering the room in which it is installed more luxurious with its refined and clean look and unmistakable warmth that only a flame can give.

PLEASE READ VERY CAREFULLY THE FOLLOWING MANUAL BEFORE INSTALLING AND USING THE STOVE.

INTRODUCTION

The pellet stove heater simply indicated as "stove", has been constructed in a conformed way in accordance with the **EN 16510 directive**, taking in account relevant technical standards, using certified components and performing regularly required check-ups to ensure its safe use and functionality.

The stove is delivered ready to be installed along with its user manual and CE declaration. The following manual contains important information that must be followed in order to use the stove in a safe manner. The user must read carefully this manual before operating the stove and must pay attention to all indications and obligations given. The stove has been designed to produce hot air for heating for domestic needs, by burning wooden pellets in accordance with the limitations given in the manual.

General safety warnings

All regulations regarding the installation and use of the stove, including those referring to National and European standards must be complied with.

For a correct functionality, the stove must be installed by qualified personnel in accordance with regulation standards and the instruction manual supplied by the manufacturer.

The stove must be used exclusively for the purpose it was designed for, any responsibility for eventual damage to things, people or animals for an improper use of the product will be held at the user's expense.

Do not use the stove as an incinerator or in any other manner other than that for which it was designed for.

Do not use fuels other than wooden pellets. Do not use liquid fuels.

Do not put pellets directly into the burner. Do not open the door whilst the stove is in function.

For its ordinary function, the user must apply all the indications derived from a thorough reading of the user and maintenance manual, and scrupulously observe the indications and signs located on the stove.

The plug of the power cable must be connected only AFTER the installation and assembly of the appliance has been concluded and must remain accessible afterwards, that is if the device does not have a suitable and accessible double-pole switch.

Before any intervention for maintenance, the stove must be disconnected from any power source. Do not remove any signs or protective casings from the stove.

Pay attention that the power cable does not touch any hot parts of the stove.

Do not turn off the stove by disconnecting the cable from the main power supply.

While the stove is in function, its outer surface can reach high temperatures so be cautious when handling to avoid burns.

The appliance cannot be used by children under the age of 8 and people with low physical, sensory or mental abilities, or without knowledge or experience required, provided that they are under surveillance or after they have been given instructions on how to safely use the appliance and they understand all hazards inherent to it.

The cleaning and maintenance intended to be performed by the user must not be performed by unsupervised children. Do not perform any unauthorized modifications to the stove. Use only original spare parts recommended by the manufacturer.

In the event the chimney flue catches fire, turn the stove off by pressing the turn off button, do not disconnect from the main power supply and contact the local fire department.

The qualified technician that will install the product, will also assume full responsibility for the final installation and the subsequent functionality of the product. There will be no liability from the manufacturer for the failure to comply with such precautions.

After unpacking the stove, make sure of the integrity of the product and completeness of the contents, in case of non-compliance, contact the dealer from whom the stove was purchased from.

The extraordinary maintenance and service procedure on the stove must be carried out at least once a year by qualified personnel, one must plan in time this operating with the technical service center.

On all MORETTI DESIGN products, at the end of the assembly line a scrupulous check-up followed by a combustion test is carried out. Therefore, we inform the customer that at the delivery of the product it is normal to find traces of combustion, which testify the testing occurred.

DESCRIPTION

Identification

Attached on the back of the stove, there is an identification plate on which the following information is written:

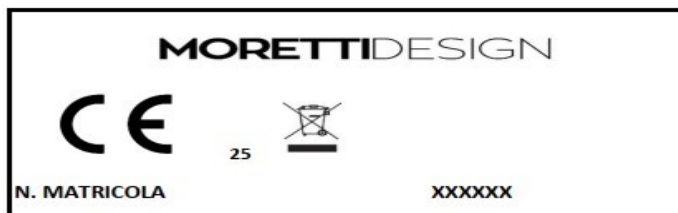

MORETTIDESIGN					
C.da Tesino 50, 63035 Ripatransone (AP) Italia					
MODELLO					
Norma di prodotto		EN 16510-1:2022, EN 16510-2-1:2022			
Designazione apparecchio		RISCALDAMENTO AMBIENTI			
Combustibile ammesso		PELLET DI LEGNO			
P nom	kW	X	P part	kW	X
PSH nom	kW	X	PSH part	kW	X
PW nom	kW	X	PW part	kW	X
η nom	%	X	η part	%	X
η s	%	X	EEl	-	
CO nom (13%O2)	mg/Nm ³	X	CO part (13%O2)	mg/Nm ³	X
NOx nom (13%O2)	mg/Nm ³	X	NOx part (13%O2)	mg/Nm ³	X
OGC nom (13%O2)	mg/Nm ³	X	OGC part (13%O2)	mg/Nm ³	X
PM nom (13%O2)	mg/Nm ³	X	PM part (13%O2)	mg/Nm ³	X
p nom	Pa	X	p part	Pa	X
p w	bar	X	s	cm	X
d R	cm	X	d s	cm	X
d c	cm	X	d p	cm	X
d f	cm	X	d L	cm	X
d B	cm	X	d non	cm	X
eI S _B	kW	X	E,f	V, Hz	X
eI max	kW	X	eI min	kW	X
	-		leggere e seguire le istruzioni per l'uso		
TEST REPORT N. ENTE			XXX IMQ S.p.A.		

Description of the stove



The pellet stove is a heat generator capable of heating air through the combustion of wooden pellets. The fuel is inserted in an automated way. The air present in the environment is heated by the flame, produced by the combustion of the pellets, and circulates in the room thanks to the ventilator. This ventilator emits warm air directly into the room where the stove is installed.

The safe use of the heater is guaranteed by the fact that on all MORETTI DESIGN products, CE certified systems are installed and they control all functions and parameters. The advanced software allows for the user a more simple and immediate comprehension of the heaters functions. The presence of a thermostat on all MORETTI DESIGN products allows the user to program the on/off switching function of the stove. The large pellet tank allows for a long period fuel loading procedure, avoiding this way that the user has to refill the tank too often. The large ash drawer allows the user to empty it just once a week when it is filled with ash (the frequency of the operation may vary depending on how long the stove is used and the quality of the pellets).

INSTALLATION

The stove must be placed on a floor with an adequate load capacity. If the building does not meet this requirement, appropriate measures (e.g. load distribution plate) must be taken.

The installation of the stove must ensure an easy access for cleaning the heater, the flue and the chimney.

Extraction fans, when used in the same room, can cause problems.

It is prohibited to install the stove in a small rooms or bedrooms. It is forbidden to install the stove in rooms exposed to a high risk of fire, in rooms with an explosive atmosphere or where other heat generators are already present whose simultaneous presence is not compatible according to standard regulations. The installation in small rooms or bedrooms can take place only if the stove is hermetic (hermetic system) and air required for the combustion must be drawn directly from the outside through a tube.

All local regulations and European standards must be met when the stove is installed.

In case of adverse draught change the flue.

In case of particular weather conditions install a wind-proof hat.

Supply conditions and unpacking

The stove is delivered packed together with its aesthetic components. To unpack the stove, cut the straps and remove the box. Use the proper equipment for lifting the appliance from the wooden pallet.

Assembling

For the installation of a MORETTI DESIGN pellet stove, contact an authorized technician (the penalty otherwise would be the void of the warranty).

Combustion air

A poor combustion can be caused by poor air circulation in the room and this often occurs in modern homes that have sealed doors and windows. The situation also becomes problematic when, on the contrary, there are air currents inside the room (generated for example by fans). To avoid this type of disadvantage, it is recommended to install a permanent ventilation grid in a window or near the stove.

If there is no possibility of connecting the air intake directly to the outside (see next paragraph), it is imperative to drill a hole in the wall for the combustion air inlet for both health and safety reasons. It is recommended the installation of an air grid over the opening and it must be kept clean.

Combustion air for a hermetic installation



The air required for the combustion must be drawn directly from the outside through a tube with a **60mm** diameter. The tube must not exceed **5m** in length and must not have more than **4 curves with a 90°** angle. It is recommended the installation of an air grid over the opening and it must be kept clean (see the following example).

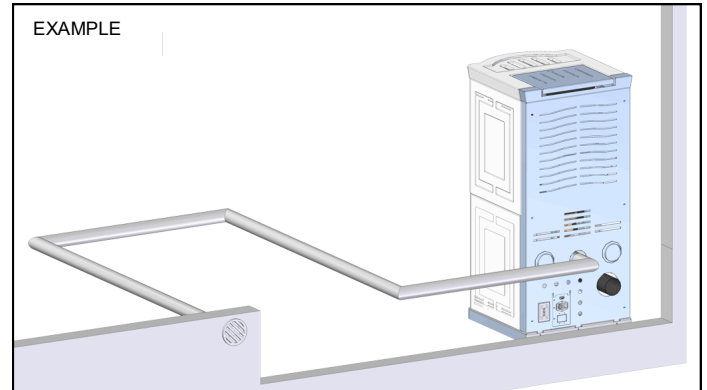

Fume exhaust

To extract the exhaust fumes, a flue must be installed in compliance with standard regulations. The stove was not designed to share the flue with other appliances.

Installation examples

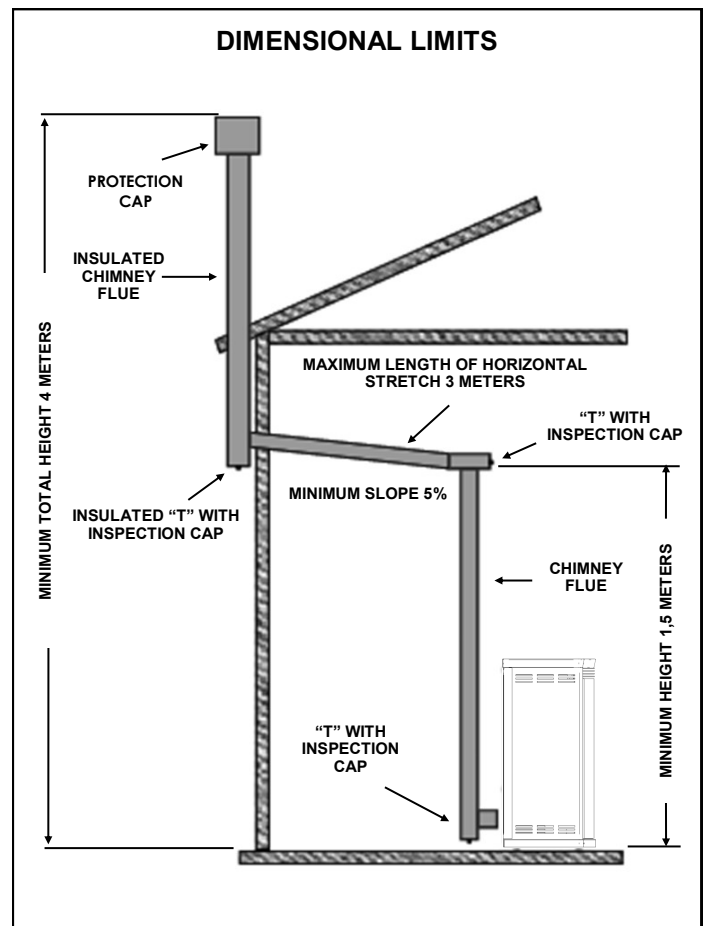

CHIMNEY FLUE INSIDE AN OLD CHIMNEY CORRECT INSTALLATION

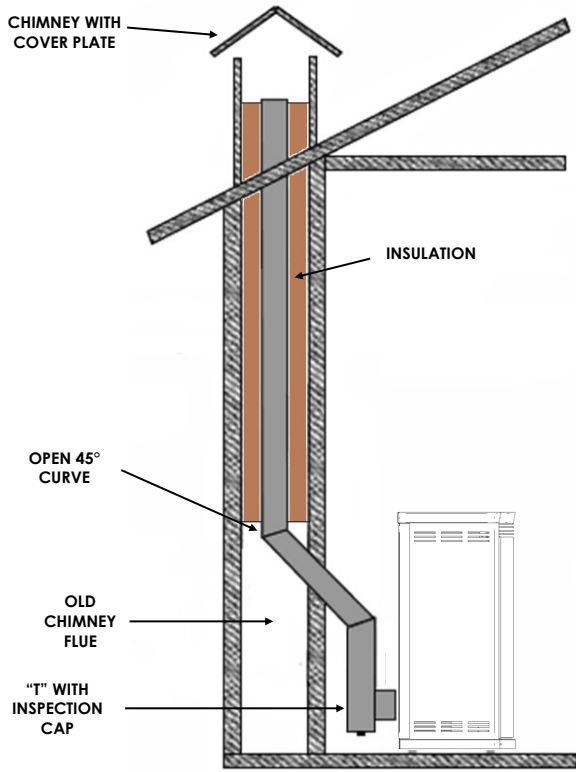

EXTERNAL CHIMNEY FLUE CORRECT INSTALLATION

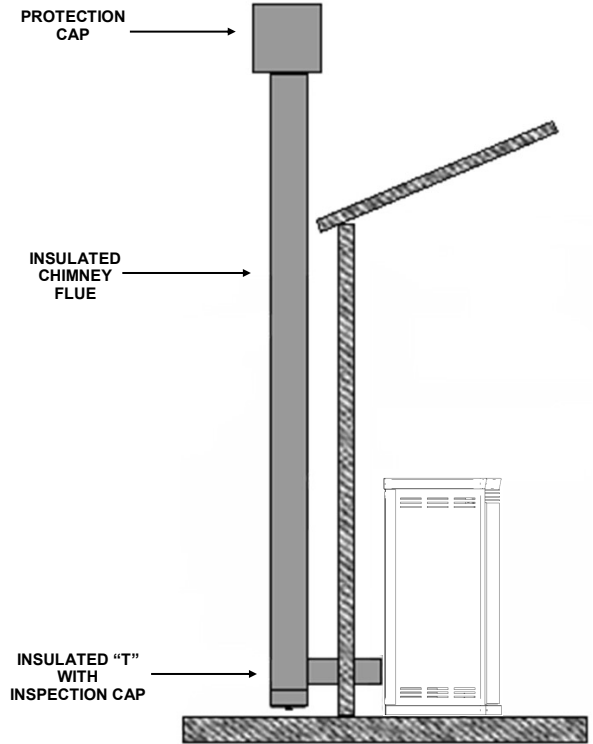

CHIMNEY FLUE WITHOUT "T" IMPROPER INSTALLATION

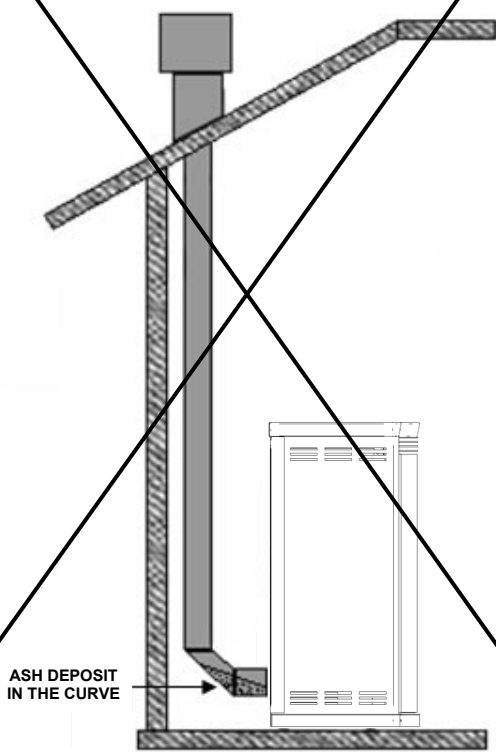

CHIMNEY FLUE THROUGH OUTSIDE WALL IMPROPER INSTALLATION

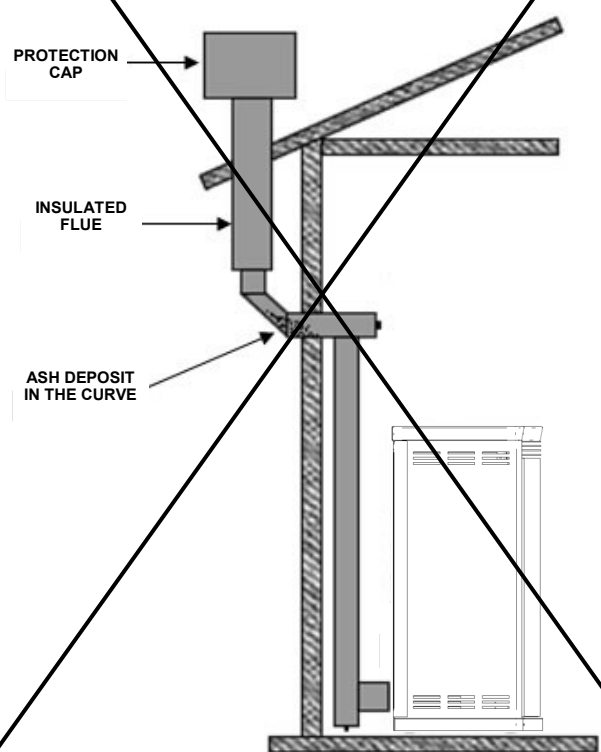

CHIMNEY FLUE THROUGH OUTSIDE WALL CORRECT INSTALLATION

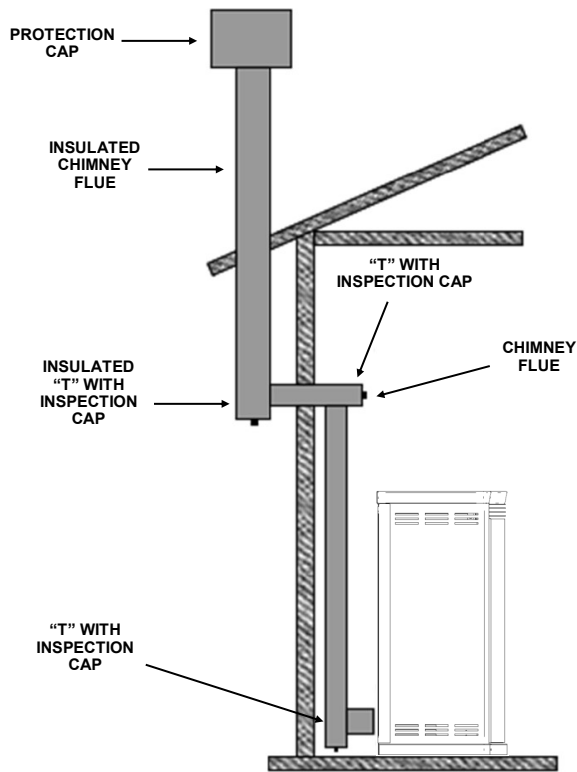

EXTERNAL FREE CHIMNEY FLUE IMPROPER INSTALLATION

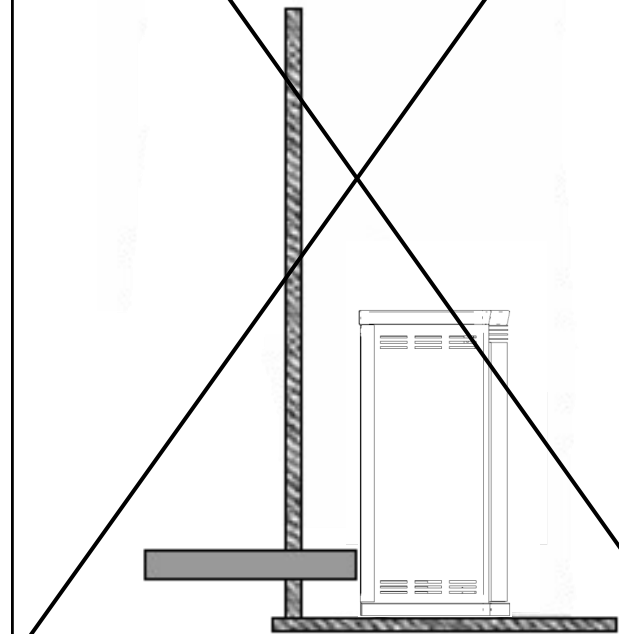

INTERNAL CHIMNEY FLUE CORRECT INSTALLATION

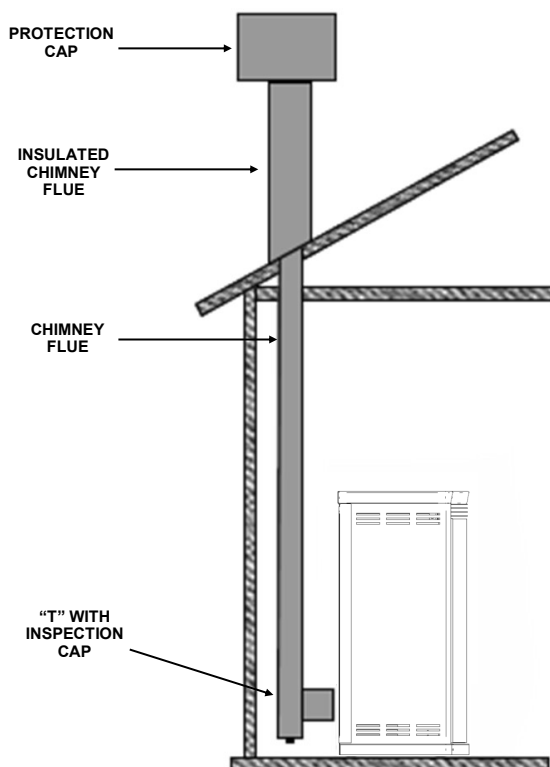

Warning:

The chimney must be constructed according to regulation standards.

For an external installation, use an insulated chimney flue that can be inspected on the curves

Do not use synthetic materials or aluminium.

Use only stainless steel tubes.

All sections of the fume exhaust must be accessible for inspections and internal cleaning.

The minimum draft at nominal power must be 10 Pa, the minimum draft at reduced power must be 5 Pa.

The outdoor section of the barrel must be insulated.

Failure to comply with the above will void the warranty.

Operating conditions

The stove has been designed to be used in ordinary environments, where there is no danger of possible fire outbreaks or explosions. Disposal of the combustion waste, must be carried out in accordance with local regulations. While using the stove, the settings can not be changed or the protective casings removed. The control devices must be adjusted by MORETTI DESIGN qualified personnel. The maintenance of the product must be carried out by companies specialized in the maintenance of heating appliances and authorized by Moretti Design, which will submit it to all the checks ups required by the local regulations.

Use only wooden pellets with a 6 mm diameter and 30mm maximum length, EN PLUS certified class A1.

Caution: A stove that has been modified or altered, must be subjected to further verifications in compliance with the law. The improper connection of the stove to the flue and the non-compliance of regulations for the installation of air vents can cause serious danger to people and will void the warranty.

Residual risks

Certain parts of the stove, in particular the glass and flue, while in use overheat and can cause burns, do not touch or handle unless with the utmost care. The electrical parts can cause serious damage, do not touch these parts without having disconnected the cable from the main power supply.

SAFETY DEVICES

Breakage of the exhaust fan: If for any reason the fan breaks, a safety measure intervenes and blocks the pellet flow (Er02), an alarm goes off and stops the stove's function.

Breakage of the auger motor: If the auger motor stops feeding pellet, the system still continues to function on minimum levels then an alarm goes off and the stove blocks (Er12, Er03).

Failed ignition: If there is a failed ignition, the stove goes into safe mode and then into block (Er12). Unblock the stove and check if the burner is clean and positioned properly before attempting another ignition.

If the burner is not cleaned, the next ignition may cause a little deflagration inside the combustion chamber. If this occurs, the manufacturer will not accept any responsibility for damage to persons, animals or things.

On models with the automatic burner cleaning function, the burner before each ignition automatically cleans itself, thus avoiding the user having to open the front door and manually cleaning it.

Electrical protection: The system is protected with a 4 A fuse that is located on the back of the stove. To replace it, extract the tray next to the switch only after disconnecting the power cable from the power supply, replace the broken fuse and reinsert the tray, if the new fuse immediately breaks, contact a technician.

Exhaust fume safety: If there are any anomalies with the smoke expulsion from the system, an alarm will go off and the system will block (Er02).

Pellet safety: If the temperature inside the pellet tank exceeds the safety level, the system blocks (Er01). The reinstatement is automatic.

Power failure: If there is a short power failure in the power supply, the system will go into block (Er15), if the lack of electricity is not brief, the stove could release a small quantity of smoke in the room, if the air intake has not been correctly connected to the outside. **This is caused by the scarce draw of the chimney flue and does not represent any risk for one's safety.** When the power comes back, the system switches itself off.

Warning: In the case the chimney catches fire, call the fire brigade.

MINIMUM SAFETY DISTANCES

Keep fuels and flammable substances at an adequate distance from the stove. For minimum distances from flammable materials, one can refer to the products identification plate located on the back of the stove.

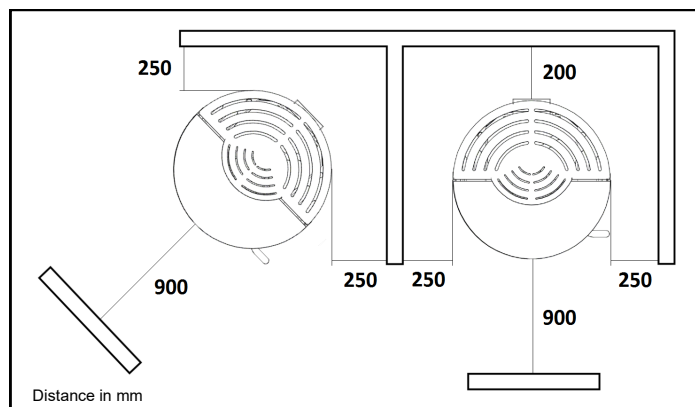

Caution: For some models the minimum safety distance from flammable materials may be different than those shown in the figure below. Therefore, always refer to the product identification plate generally located on the back of the stove to ensure minimum safety distances for the specific model.

Note: If one wants to install the stove near a non-flammable wall, it is possible to place it directly in contact with the wall, as long as it does not obstruct any access to the electrical components or connections or maintenance interventions.

FIRST IGNITION

Caution: The first ignition must be carried out by MORETTI DESIGN qualified personnel that must also perform an overall check up of the system.

All local and National laws and European standards must be met when using the appliance.

Positioning the deflector

Before turning on the stove, it is necessary to insert the deflector inside the combustion chamber (see dedicated manual).

Note: Once a month remove and clean the deflector. A failure to clean can compromise the proper function of the stove.

Pellet loading



Fill the fuel tank with wooden pellets. Open the lid and then pour the fuel in. **Please remember to securely close the lid of the pellet tank to ensure a perfect seal and the correct functioning of the product.**

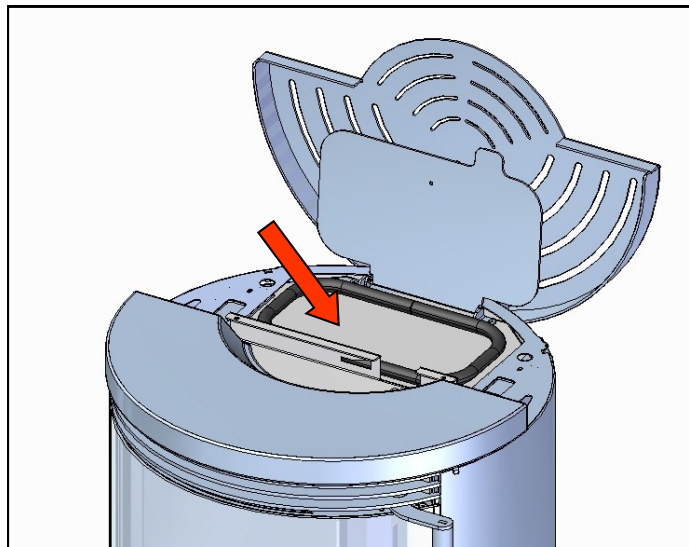

Use only wooden pellets with a 6 mm diameter and 30mm maximum length, EN PLUS certified class A1.

Warning: Before filling the tank, make sure that at the bottom there are no odd materials.

Ignition mode

Make sure that the stove is connected to the electrical power and that the switch on the back is on position "I"

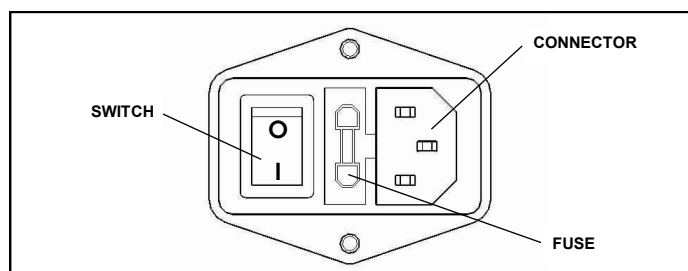

Fill the auger by using the **INITIAL LOAD** function (see page 14). During the ignition or even in run mode, the front door must always be kept closed.

Before turning on the stove, empty out the burner once the initial load function has been carried out.

See **REMOTE CONTROL** (page 11) on how to turn on the appliance, adjust the room temperature and combustion power level and for more information regarding the various menus.

COMBUSTION

The combustion is a chemical reaction in which a fuel (pellets) and an oxidiser (air) are combined, thanks to an ignition (resistance), in order to produce heat. They should be dosed in suitable proportions so that the combustion can take place. Following are some examples with a description and adjustment procedure to obtain an optimal combustion.

Note: On models where the FCS (or MCS) system is installed on, in **CALIBRATION** (page. 14) only the **TYPE PELLETT** appears. If the FCS is not present then both **TYPE PELLETT** and **TYPE CHIMNEY** appear.

Example 1



NON OPTIMAL combustion, the flame is high and weak and is of an intense orange colour also a large amount of unburned pellets are left over inside the burner.

- First of all check if the front door is closed properly and if the gaskets seal off properly the combustion chamber. Then increase the **TYPE CHIMNEY** setting (models without FCS) one point at a time (from 0 to +9). If it is not enough, reduce the **TYPE PELLETT** setting one point at a time (from 0 to -9) until the example 3 condition is achieved.

Example 2

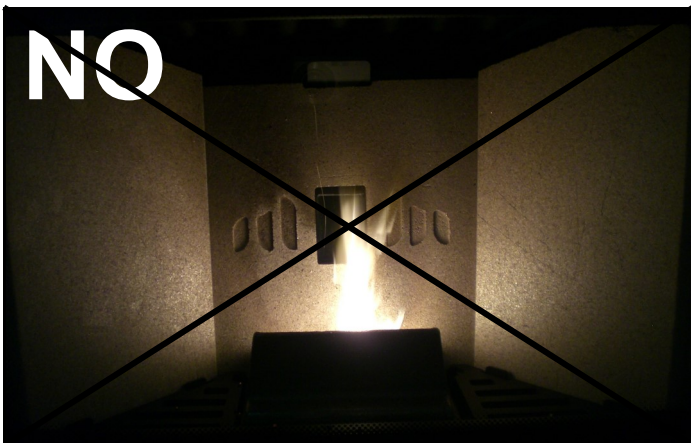

NON OPTIMAL combustion, the flame is too stretched and a large amount of burning pellets are blown out of the burner.

- Reduce the **TYPE CHIMNEY** setting (models without FCS) one point at a time (from 0 to -9). If it is not enough, then increase the **TYPE PELLETT** setting one point at a time (from 0 to +9) until the example 3 condition is achieved.

Example 3



OPTIMAL combustion, the flame is vibrant of a yellow/white colour with a small amount of burning pellets inside the burner. It is not necessary to adjust any settings in the **CALIBRATION** menu.

For all three of the examples, it is advised to evaluate on the spot all necessary adjustments.

FCS (Fire Control System)



It is an automatic combustion control system that maintains the products high efficiency. The system automatically adjusts the fuel (pellets) and combustion air dosage according to the draw read from the flowmeter sensor located inside the stove.

Also with the FCS system activated, it is recommended to check the quality of the flame by comparing it with the images of the above examples.

In the case of a **NON OPTIMAL** combustion, despite the FCS system is activated, contact an authorized technician.

CONNECTION AND DESCRIPTION ON HOW A DUCT-ED STOVE OPERATES



Ducted pellet stoves include, in addition to the front ventilator (**F**), also ventilators dedicated for ducting warm air. There are models where there is only one ventilator installed, these stoves are equipped with a single hot air duct (**CN**), while there are other models where there are two ventilators installed, these stoves are equipped with two hot air ducts (**DX**, **SX**).

The ducts for conveying warm air from the stoves output (80 mm) must not exceed **7 meters** in length and must not have more than **4 curved sections**, only for model Aladino, Clessidra, Elegance and Ergonomic. We recommend the use of smooth insulated rigid steel pipes.

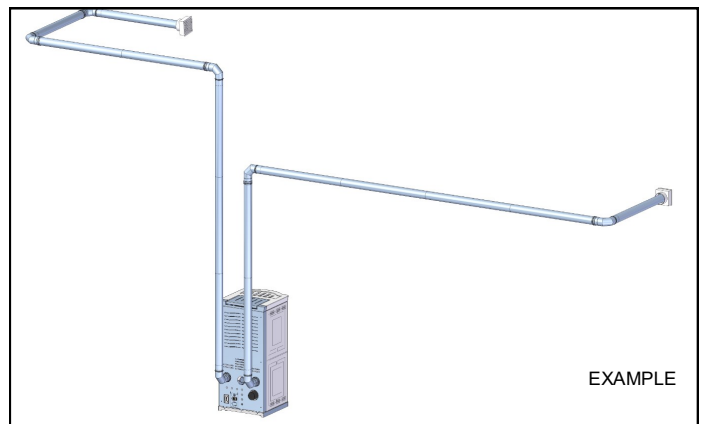

Optional

For a proper use of a ducted stove, it is appropriate that for each ducted output a room sensor (model NTC 10k at 25°) or an ON/OFF thermostat or a wireless thermostat is connected. A stove without the above components connected can never go into Modulation. Observe the technical data sheet on the product manual in order to verify where the connectors for connecting the sensors or thermostats are located on the back of the stove.

Note: The configurations **MAN** and **AUTO** will be described in the next pages. They can be set directly by the user. Regarding the **AUTO** setting, this configuration can be enabled by the installer during the first ignition phase.

Note: With the **AUTO** configuration set, the fans will go into Modulation when the SET temperature is reached.

Note: With the **MAN** configuration set, the back fans operate manually (this configuration is used in the absence of room sensors or ON/OFF thermostats).

Single ducted outlet (CN) stove function

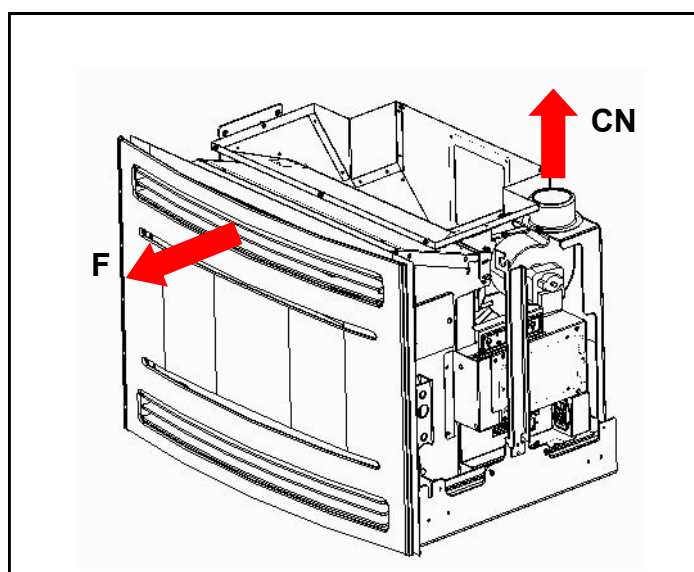

MANUAL: Set the **Fan Mode** (page 14) to **MAN**.

In this mode it is possible to set the operating power of the CN outlet fan independently from the set temperature and power level on the stove, whether a room sensor or an ON/OFF thermostat or radio thermostat has been connected.

- To access the fan power setting from the main screen, press the **P5** button. To change the power setting, simply press the **P2** button, press the **P4** button to confirm. The display shows the set value.
DISPLAY: to access the fan power adjustment from the main screen, press button **5**. To change the power level, simply use buttons **1** and **2**; to confirm, press **5**. The display shows the set value.

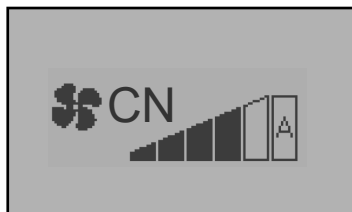

When the room temperature reaches the set value (SET ROOM TEMP), the stove goes into Normal Modulation, the front F fan runs at minimum speed and the CN fan continues to run independently depending on the set power level (CN).

If **A** is set, when the room temperature reaches the set value on the stove (SET ROOM TEMP), the stove goes into Modulation and the F, CN fans run at minimum speed.

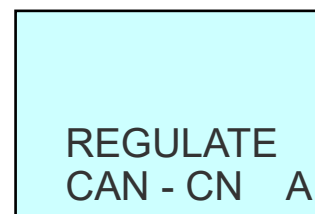
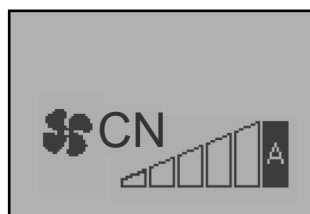

AUTOMATIC: Set the **Fan Mode** (page 14) to **AUTO**.

1) SOND: It is possible to set the CN outlet temperature when a room sensor is connected to the stove.

- To enter **REGULATE CN** press the **P5** button, to change the temperature of the CN outlet sensor, simply press the **P1** and **P2** buttons, press **P4** to confirm. The display shows the current status of the set temperature.
DISPLAY: to access **REGULATE CN**, press button **5**. To modify the temperature related to the ambient probe of the CN output, simply use buttons **1** and **2**; to confirm, press **5**. The display shows the current temperature SET status.

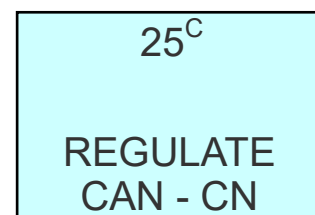

When the room temperature reaches the set value on the stove (SET ROOM TEMP), but not the SET temperature for the CN fan (REGULATE CN), the stove continues to operate at its set power (POWER SET), the F fan runs at minimum speed and the CN fan continues to run at the set power level on the stove.

When the room temperature has not yet reached the set value on the stove, but has reached the SET temperature for the CN fan, the stove continues to operate according to the set power level together with the F fan and the CN fan runs at minimum speed.

When the room temperature reaches both the set value on the stove and the SET temperature for the CN fan, the stove goes into Normal Modulation and the F, CN fans run at a minimum.

2) NO S: No room sensor has been connected to the stove.

- It is not possible to SET the temperature on the Remote Control. If you press the **P5** button, you can adjust the power level using the **P2** button. To confirm, press **P4**.
DISPLAY: it is not possible to change the temperature SET on the display. If button **5** is pressed, the power can be adjusted using button **2**; to confirm, press **5**.

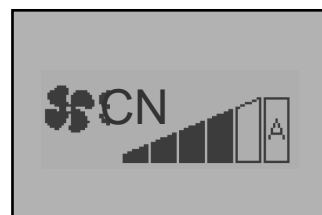

When the room temperature reaches the set value on the stove (SET ROOM TEMP), the stove goes into Modulation and the fans (F, CN) run at minimum speed.

3) TERM: When an ON/OFF thermostat or radio thermostat is connected to the stove, it is possible to set the CN outlet temperature directly on the thermostat.

- The SET temperature can not be changed on the Remote Control and if the **P5** button is pressed the display will show the status of the contact.
DISPLAY: it is not possible to change the temperature SET on the display, and if button **5** is pressed, the display shows the status of the contact.

N.B. The images below are not representative of the product and are provided for illustrative purposes only.



CLOSED CONTACT



OPEN CONTACT

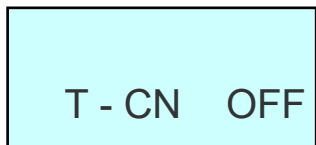

CLOSED CONTACT

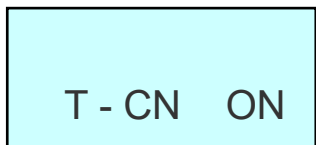

OPEN CONTACT

When the room temperature reaches the set value on the stove (SET ROOM TEMP), but not the SET temperature on the ON/OFF thermostat or radio thermostat for the CN fan, the stove continues to operate at its set power (POWER SET), the F fan runs at minimum speed and the CN fan (CLOSED contact) continues to run at the set power level on the stove.

When the room temperature has not yet reached the set value on the stove, but has reached the SET temperature on the ON/OFF thermostat or radio thermostat for the CN fan, the stove continues to operate according to the set power level together with the F fan and the CN fan (OPEN contact) runs at minimum speed.

When the room temperature reaches both the set value on the stove and the SET temperature on the ON/OFF thermostat or radio thermostat for the CN fan, the stove goes into Normal Modulation and the F, CN (OPEN contact) fans run at a minimum.

Double ducted outlet (DX, SX) stove function

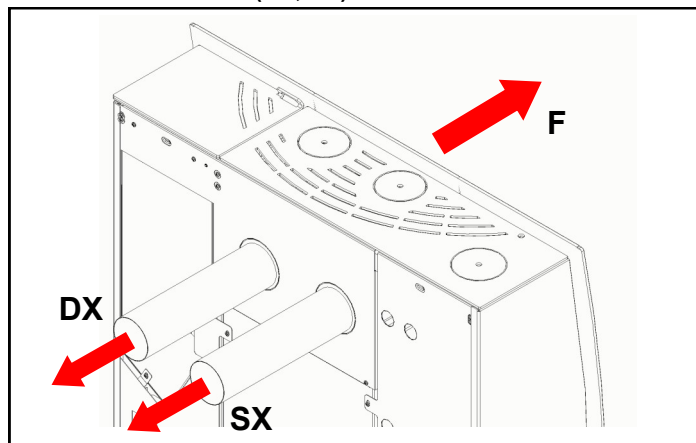

MANUAL: Set the Fan Mode (page 14) to **MAN**.

In this mode it is possible to set the operating power of the DX and SX outlet fans independently from the set temperature and power level on the stove, whether room sensors or ON/OFF thermostats or radio thermostats have been connected.

- To access the fan power setting from the main screen, press the **P5** button. To change the power setting of the DX fan, simply press the **P1** button, to change the power setting of the SX fan press the **P2** button, press the **P4** button to confirm. The display shows the set value.
DISPLAY: to access the fan power adjustment from the main screen, press button **5**. To adjust the power of the DX output, press **1**; to adjust the power of the SX output, press **2**. To confirm, press **5**. The display shows the set value.

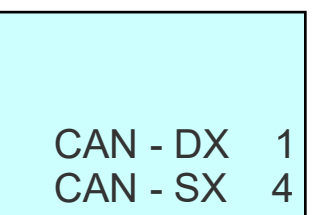
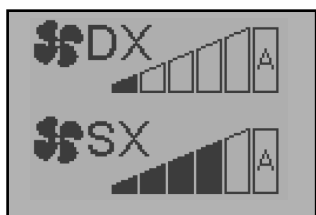

When the room temperature reaches the set value (SET ROOM TEMP), the stove goes into Normal Modulation, the front F fan runs at minimum speed and the DX and SX fans continue to run independently depending on the set power level (DX, SX).

If **A** is set, when the room temperature reaches the set value on the stove (SET ROOM TEMP), the stove goes into Normal Modulation and the F, DX, SX, fans run at minimum speed.

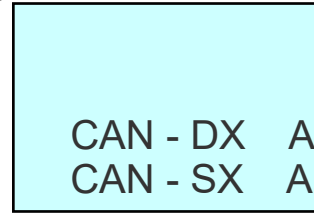
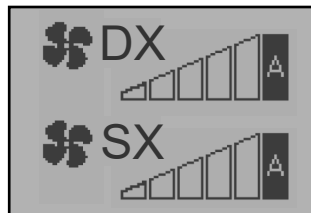

AUTOMATIC: Set the Fan Mode (page 14) to **AUTO**.

1) SOND: It is possible to set the DX and SX outlet temperatures when a room sensors are connected to the stove.

- To enter **REGULATE CAN-DX** press the **P5** button (press the **P5** button again for **REGULATE CAN-SX**), to change the temperatures of the DX and SX outlet sensors, simply press the **P1** and **P2** buttons, press **P4** to confirm. The display shows the current status of the set temperature.
DISPLAY: to access **REGULATE CAN-DX**, press button **5** (press **5** for **REGULATE CAN-SX**). To modify the temperature related to the ambient probes of the DX and SX outputs, simply use buttons **1** and **2**; to confirm, press **5**. The display shows the current temperature SET status.

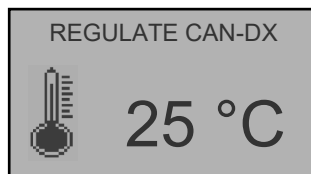

RIGHT OUTLET

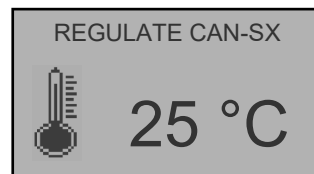

LEFT OUTLET

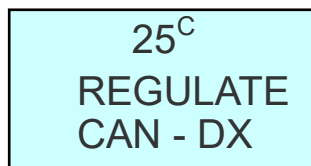

RIGHT OUTLET

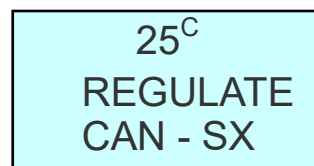

LEFT OUTLET

When the room temperature reaches the set value on the stove (SET ROOM TEMP), but not the SET temperature for the DX and SX fans (REGULATE CAN-DX, REGULATE CAN-SX), the stove continues to operate at its set power (POWER SET), the F fan runs at minimum speed and the DX, SX fans continue to run at the set power level on the stove.

When the room temperature reaches the set value on the stove and also the SET temperature of one of the ducted outlets (for example the DX), the stove continues to operate at its set power, the F and DX fans run at minimum speed and the SX fan, which has not yet reached the set value, continues to run at the set power level on the stove.

When the room temperature has not yet reached the set value on the stove, but has reached the SET temperature for the DX and SX fans, the stove continues to operate according to the set power level together with the F fan and the DX and SX fans run at minimum speed.

When the room temperature reaches both the set value on the stove and the SET temperatures for the DX and SX fans, the stove goes into Normal Modulation and the F, DX, SX fans run at a minimum.

2) NO S: No room sensors have been connected to the stove.

- It is not possible to SET the temperature on the Remote Control. To access the fan power setting from the main screen, press the **P5** button. To change the power setting of the DX fan, simply press the **P1** button, to change the power setting of the SX fan press the **P2** button, press the **P4** button to confirm. The display shows the set value.
DISPLAY: it is not possible to change the temperature SET on the display. If button **5** is pressed, the power can be adjusted using button **1** (for CAN-DX) and button **2** (for CAN-SX); to confirm, press **5**.

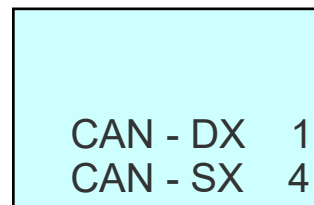
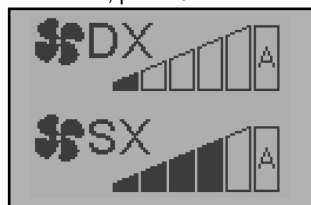

When the room temperature reaches the set value on the stove (SET ROOM TEMP), the stove goes into Modulation and the fans (F, DX, SX) run at minimum speed.

3) TERM: When ON/OFF thermostats or radio thermostats are connected to the stove, it is possible to set the DX and SX outlets temperature directly on the thermostats.

- The SET temperature can not be changed on the Remote Control and if the **P5** button is pressed the display will show the status of the contacts.

DISPLAY: it is not possible to change the temperature SET on the display, and if button **5** is pressed, the display shows the contact status.

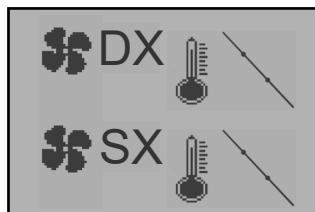

**CLOSED DX CONTACT
CLOSED SX CONTACT**

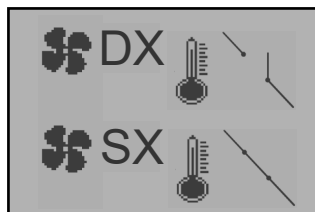

**OPEN DX CONTACT
CLOSED SX CONTACT**

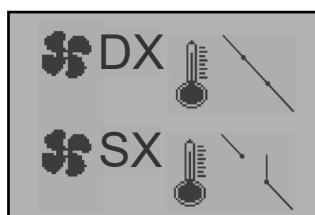

**CLOSED DX CONTACT
OPEN SX CONTACT**

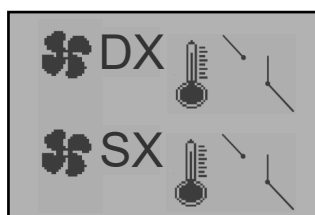

**OPEN DX CONTACT
OPEN SX CONTACT**

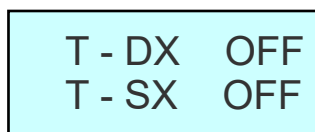

**CLOSED DX CONTACT
CLOSED SX CONTACT**

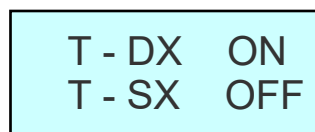

**OPEN DX CONTACT
CLOSED SX CONTACT**

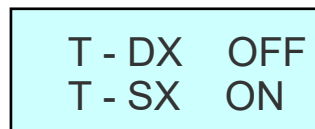

**CLOSED DX CONTACT
OPEN SX CONTACT**

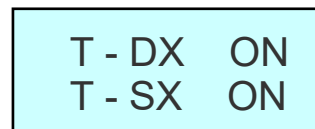

**OPEN DX CONTACT
OPEN SX CONTACT**

When the room temperature reaches the set value on the stove (SET ROOM TEMP), but not the SET temperature on the ON/OFF thermostats or radio thermostats for the DX and SX fans, the stove continues to operate at its set power (POWER SET), the F fan runs at minimum speed and the DX and SX fans (both CLOSED contact) continue to run at the set power level on the stove.

When the room temperature reaches the set value on the stove and also the SET temperature on the ON/OFF thermostat or radio thermostat of one of the ducted outlets (for example the DX), the stove continues to operate at its set power, the F and DX (OPEN contact) fans run at minimum speed and the SX fan, which has not yet reached the set value (CLOSED contact), continues to run at the set power level on the stove.

When the room temperature has not yet reached the set value on the stove, but has reached the SET temperature on the ON/OFF thermostats or radio thermostats for the DX and SX fans, the stove continues to operate according to the set power level together with the F fan and the DX and SX fans (both OPEN contact) run at minimum speed.

When the room temperature reaches both the set value on the stove and the SET temperature on the ON/OFF thermostats or radio thermostats for the DX and SX fans, the stove goes into Normal Modulation and the F, DX (OPEN contact), SX (OPEN contact) fans run at a minimum.

MANUAL ADJUSTMENT OF THE HEATING FAN SPEED (RELAX MODEL)



The Relax model is the only one where you can manually deactivate the heating fans, regardless of the combustion power setting, since the stove is a model that works mainly by natural convection. By activating the ventilation you can choose between 5 manual power levels or set the automatic mode.

- To access the fan speed setting from the main screen, press the **P5** button. Once logged in, simply use the **P1** and **P2** buttons to select one of the available settings (there are 5 speed levels + Auto + OFF), to confirm press **P4**. The display shows the selected value.

DISPLAY: to access the fan speed adjustment from the main screen, press button **5**. Once inside, simply use buttons **1** and **2** to choose one of the available settings (there are 5 speed levels + Auto + OFF); to confirm, press **5**. The display shows the selected value.

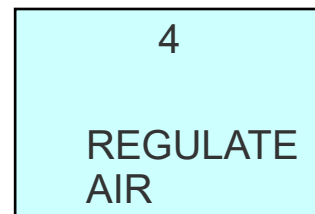
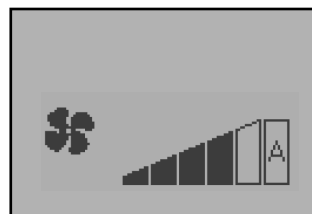

If **A** (Automatic) is set, the heating fans will work at a set speed depending on the selected combustion power level.

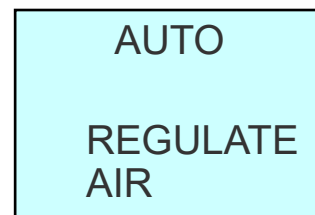
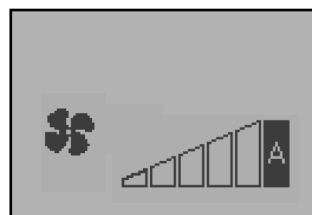

If **OFF** is set, the heating fans will be turned off and the product will work by natural convection.

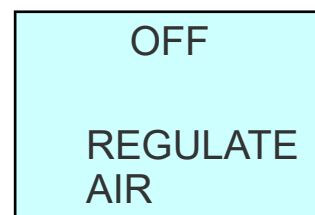
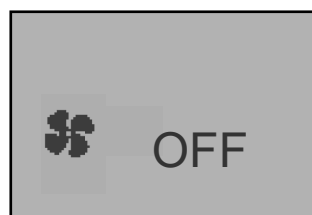

Note: in case of high fume temperature, the fans will be activated automatically for a safety issue to cool the stove down.

OPENING AND CLOSING THE FRONT GLASS DOORS (COMPACT DESIGN MODEL)

The COMPACT DESIGN model is equipped with a feature that allows the front glass doors to mechanically slide open and close. To activate the function both for opening and closing it is necessary to press for 5 seconds the **P2** button of the **EMERGENCY CONTROL PANEL** (see page 15).

Warning: it is strictly forbidden to touch or place your hand near the moving windows during the opening or closing phase.

If the front windows are closed and the stove is switched on (by pressing the **P3** button on the remote control for a few seconds), they will open automatically.

If the front windows are open and the stove is switched on (by pressing the **P3** button on the remote control for a few seconds), the automatic opening phase will be completely excluded.

When the stove is switched off (by pressing the **P3** button on the remote control for a few seconds) and the turn off phase is completed, the front windows will remain open and must be closed by pressing the **P2** button of the **EMERGENCY CONTROL PANEL** for 5 seconds.

The stove can not work if the front windows remain closed. The **SIC25** will be activated after a few seconds (see page 21).

REMOTE CONTROL

Introduction



The remote control displays information regarding the status of the stove. By accessing the menu it is possible to obtain various types of visualizations and make the available settings depending on the access level. Depending on the operating mode, the visualizations can assume different meanings depending on the position on the display.

ROOM TEMPERATURE

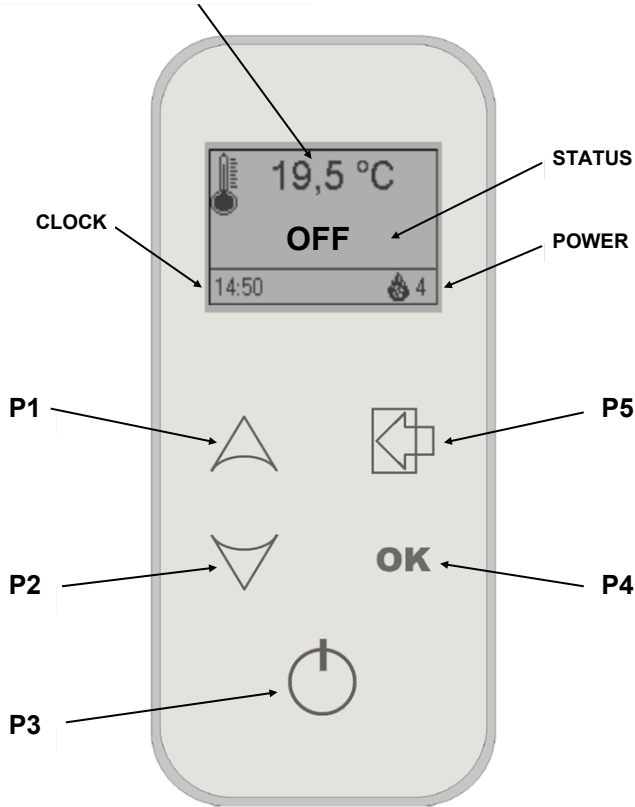

The remote control requires 3 AAA \ LR03 1.5V alkaline batteries. Insert them by following the correct polarity, as shown in the figure below.

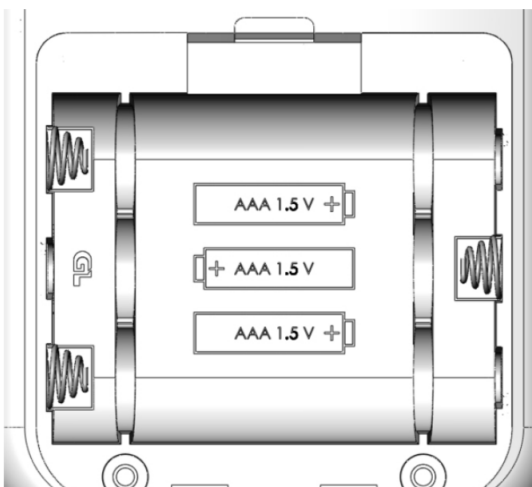

Button description

Button	Description	Mode	Function
P1	Increase Temperature/Power	PROGRAM	Change/increase value in the selected menu
		WORK	Increase set value of the room temperature and power level
P2	Decrease Temperature/Power	PROGRAM	Change/decrease value in the selected menu
		WORK	Decrease set value of the room temperature and power level
P3	ON/OFF Unblock	WORK	If pressed for more than 2 seconds the stove turns on or turns off if it was already on Press P3 key and then P4 key to start and stop the stove (starting from 2024 models)
		UNBLOCK	Unlocks the Remote Control from stand-by
		MENU/PROGRAM	Moves to the top of the menu, memorizes the set changes
P4	OK	HOME	Accesses the MENU
		MENU	Accesses the next level of the sub-menu
		PROGRAM	Sets value and skips to the next item in the menu
P5	ESC	HOME	Accesses the fan ducting settings (if present)
		MENU	Returns to previous menu
		PROGRAM	Sets value and returns to the top of the menu

Remote control channel change

In order to change the Remote control radio channel radio:

- Turn off the main switch located on the stove.
- Press and hold down simultaneously the **P3** and **P4** buttons for about 5 seconds. The following screen appears indicating the set channel:

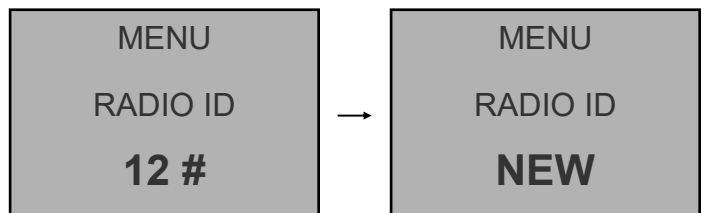

- Press the **P2** button and select **NEW** with the **P4** button.
- Now use the **P1** and **P2** buttons to select the desired channel and confirm with the **P4** button the new channel.
- Turn back on the main switch located on the stove 2 seconds after the **P4** button has been pressed.

OPERATING STATUS

Below are described the normal functions of the Remote Control of the stove with a reference to the operations available to the user. The information given below refers to the Remote Control equipped with a programmable thermostat option.

Ignition of the stove

In order to turn on the stove, press and hold down the **P3** button for a few seconds. The ignition starts when the word **CHECK UP** appears on the display. It is then followed by: **PREHEAT - LOAD PELLETT - FLAME WAIT - STABILIZATION**.

Stove in work mode

When the ignition phase has been carried out successfully, the stove switches to the working mode which represents the normal operating mode. The status is indicated on the display with the word **WORK**.

Room temperature setting

Once you enter the **SET ROOM TEMP** menu by pressing the **P1** button, to change the room temperature simply use the **P1** and **P2** buttons, press **P4** to confirm. The display shows the current status of the SET temperature.

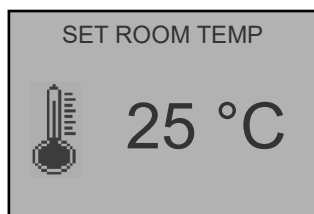

Ducted outlets temperature setting (C Models)

For this operation, see **CONNECTION AND DESCRIPTION ON HOW A DUCTED STOVE OPERATES** on page 7.

Combustion power setting

Once you enter the **POWER SET** menu by pressing the **P2** button, to change the combustion power level simply use the **P1** and **P2** buttons, press **P4** to confirm. The display shows the current status of the SET power level.

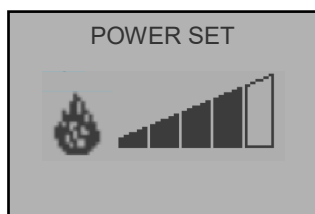

The room temperature reaches the SET temperature

When the room temperature has reached the set value, the combustion is automatically brought to a minimum, Modulation condition. This status is indicated as **MODULAZIONE** on the display (the SET power level remains, but it is automatically set to minimum).

Turning off the stove

In order to turn off the stove, press and hold down the **P3** button for a few seconds. The auger immediately stops and the exhaust fan runs at high speed. The status is indicated on the display with the word **FINAL CLEANING**.

When this phase is completed, the exhaust fan stops and the word **OFF** appears on the display.

Note: Turn off the stove in case of failure or malfunction

THE MENUS

To access the menu press the **P4** button.

The menu is subdivided into various items that allow you to access settings and programming.

The items in the menu that allow access to technical programming are password protected.

Order	User menu
1	ECO CLIMA
2	CHRONO
3	TIME AND DATE
4	LANGUAGE
5	SETTINGS
6	INITIAL LOAD
7	FAN MODE
8	MONITOR
9	WIFI STATUS
10	CALIBRATION
11	SYSTEM MENU

Eco clima

Activates the **ECO CLIMA** mode that brings the stove to turn off after the room temperature has remained above the SET temperature plus a delta for a certain amount of time.

The word **ECO-CLIMA** appears on the display (this mode is activated in **MODULATION** once the SET ROOM TEMP has been reached) and will start a timer, which once expired will activate the **STAND-BY** mode and then the stove will start the **FINAL CLEANING**.

After the **FINAL CLEANING** the stove remains in **STAND-BY** waiting for the room temperature to drop below the SET ROOM TEMP + DELTA, in order to restart the ignition.

The **STAND-BY** activates when all the SET ROOM TEMP are reached, while the ignition is only controlled by the temperature of the SET ROOM TEMP.

- To select the item in the menu use the **P1** and **P2** buttons, press **P4** to confirm.

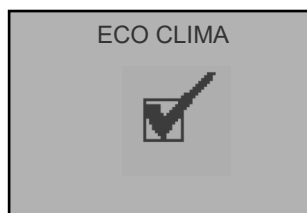

ON

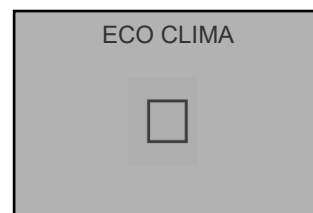

OFF

Chrono



This menu is used for setting the on/off switching time frames of the stove.

Enable Chrono: Allows to enable and disable globally all timer thermostat functions, to select use the **P1** and **P2** buttons, press **P4** to confirm.

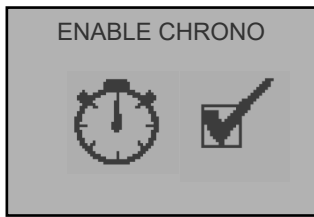

ON

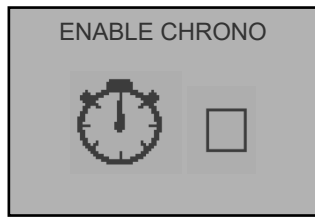

OFF

Daily chrono: Allows to enable, disable and set the daily timer thermostat function.

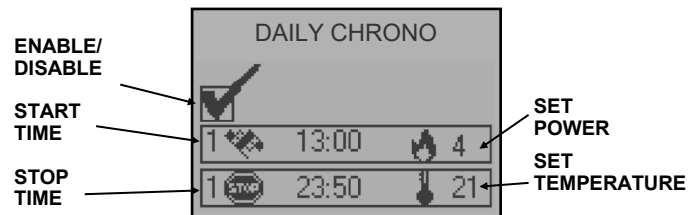

It is possible to set the time frames defined by the set times where the OFF setting means the clock will ignore the signal.

- To access and to select between: **ENABLE / DISABLE, START TIME, STOP TIME, SET POWER, SET TEMPERATURE** use the **P4** button.
- Set the values of the selected items by using the **P1** and **P2** buttons, press **P4** to confirm.

The Daily chrono has **2** independent programmable time frames for each day.

Weekly chrono: Allows to enable, disable and set the weekly timer thermostat function.



It is possible to set the time frames defined by the set times where the OFF setting means the clock will ignore the signal.

- To access and to select between: **ENABLE / DISABLE, START TIME, STOP TIME, SELECT DAY, SET POWER, SET TEMPERATURE** use the **P4** button.
- Set the values of the selected items by using the **P1** and **P2** buttons, press **P4** to confirm.

The Weekly Chrono has **4** independent programmable time frames, the final effect of which is the combination of the 4 individual programs.

Chrono weekend: Allows to enable, disable and set the timer thermostat function on weekends (days 6 and 7, Saturday and Sunday).



It is possible to set the time frames defined by the set times where the **OFF** setting means the clock will ignore the signal.

- To access and to select between: **ENABLE / DISABLE, START TIME, STOP TIME, SET POWER, SET TEMPERATURE** use the **P4** button.
- Set the values of the selected items by using the **P1** and **P2** buttons, press **P4** to confirm.

The Chrono week-end has **2** independent programmable time frames for the week-end.

Warning: Carefully program the time frames in order to avoid the overlapping of the enabled and /or disabled operating hours of the same day in different programs.

Note: in order to avoid undesired ignitions and turn-offs, it is recommended to activate only one program at a time, namely:

- Deactivate the daily chrono if you want to use the weekly one.
- Always keep the chrono week-end off when you use the weekly chrono in programs 1, 2, 3 and 4.
- Activate chrono week-end only after you have deactivated weekly chrono.

Time and Date

Sets the current date and time.

- To select the item in the menu use the **P1** and **P2** buttons, press **P4** to confirm.



The control unit is equipped with a lithium battery which allows the internal clock to have an autonomy for more than 4/5 years.

Language

It allows you to select the menu language.

- Use the **P1** and **P2** buttons to select a language from the available ones, press **P4** to confirm.

Settings

Buzzer mode: Allows you to enable and disable the control unit's feedback sound.

- To enable it use the **P1** and **P2** buttons, press **P4** to confirm.

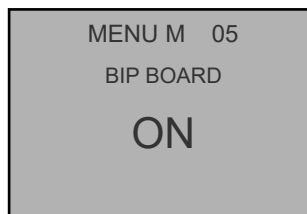

ENABLE

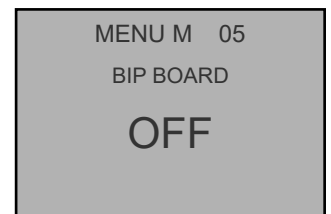

DISABLED

Backlight ON: Allows you to set how long (seconds) the backlight of the remote control remains on.

- To increase and decrease use the **P1** and **P2** buttons, press **P4** to confirm.

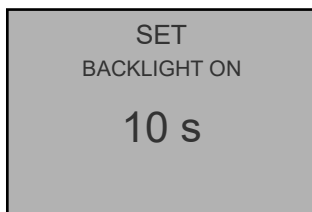

Power ON: Allows you to set how long (seconds) the remote control remains active before entering standby.

- To increase and decrease use the **P1** and **P2** buttons, press **P4** to confirm.

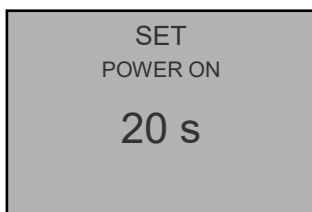

Brightness: Enables and disables the backlight of the remote control.

- To do so, use the **P1** and **P2** buttons, press **P4** to confirm.



ENABLED



DISABLED

Contrast: Allows you to adjust the contrast of the remote control.

- To increase and decrease use the **P1** and **P2** buttons, press **P4** to confirm.



Buzzer: Allows you to enable and disable the remote control's feedback sound.

- To do so, use the **P1** and **P2** buttons, press **P4** to confirm.

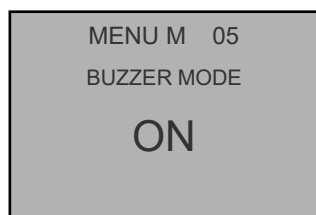

MANUAL

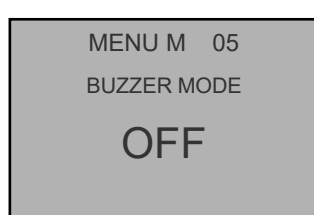

AUTOMATIC

Initial load

With the stove off and cool, the function allows a pellet preload for a time of 90" (seconds).

- To activate press the **P1** button, **wait** for the timer to start and stop by pressing the **P3** button.

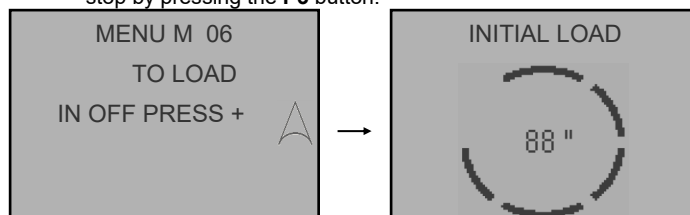

Advanced Menu

WARNING: This menu is reserved for the exclusive use of the technician. Do not change the set values.

Fan mode (only for C models)

It allows to control the ventilation of the ducted outlets in **MANUAL** or **AUTOMATIC**.

- To do so, use the **P1** and **P2** buttons, press **P4** to confirm.

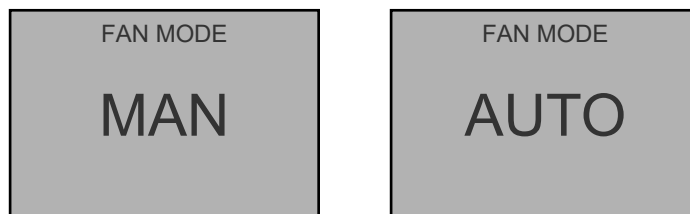

MANUAL

AUTOMATIC

See **CONNECTION AND DESCRIPTION ON HOW A DUCTED STOVE OPERATES** on page 7 for further details.

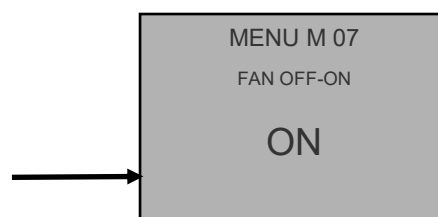
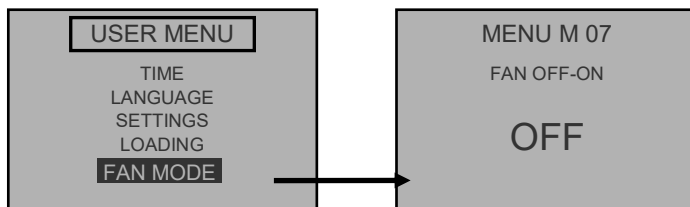

Allows to use the relax mode with installed ducting for HYBRID stoves: Compact, Aladino, Clessidra, Dream, Elegance, Ergonomic. Fan deactivation works for the power P1, P2,P3, while the power P4 and P5 the fan works automatically.

Monitor

Displays a series of operating parameters of the stove.

- To move the cursor in the menu use the **P1** and **P2** buttons, to exit press the **P5** button.

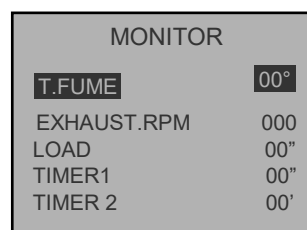

WiFi Status (optional if provided) or LED-MODE(only on models with led)

Enable, Disable and set the Auto function of the led operation

- OFF -- Led always off
- ON -- Led always on
- Auto-- The LEDs will light up when the stove goes on and for the entire period of operation, they will turn off when the state of the stove will switch off.

To make it work use the keys P1 and P2, to confirm press P4

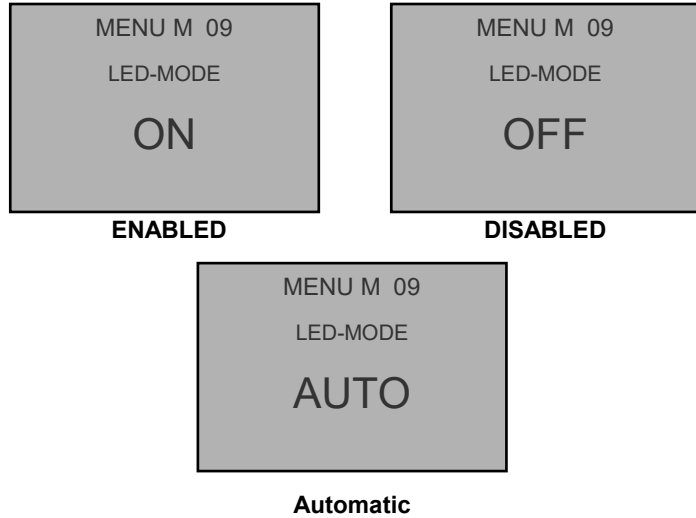

Calibration

This menu allows the adjustment of the combustion parameters.

Type pellet: Menu for changing the operating time of the Auger.

- To increase and decrease the value use the **P1** and **P2** buttons, press **P4** to confirm and **P5** to exit.

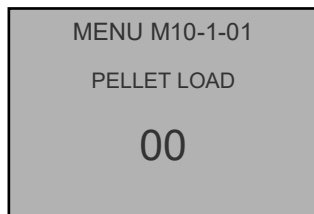

Type chimney (only for models without FCS): Menu for changing the exhaust fan speed.

- To increase and decrease the value use the **P1** and **P2** buttons, press **P4** to confirm and **P5** to exit.



See **COMBUSTION** on page 7 for further details.

System menu

This menu allows to access the Settings technic reserved for Technical Service Centers. The KEY ACCESS is password protected.

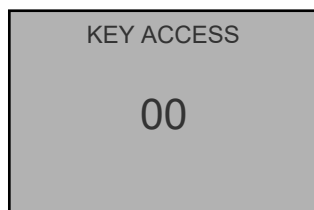

EMERGENCY CONTROL PANEL

The emergency control panel displays via LED information regarding the status of the stove, such as safety alarms and the radio connection.

It is possible to turn the stove on and off, increase and decrease the power level, with the panel buttons.

With **DECREASE LED** lit, the combustion power level is at **1** (min)

With the **DECREASE LED** and **INCREASE LED** lit, the combustion power level is at **3**

With the **INCREASE LED** lit, the combustion power level is at **5** (max)

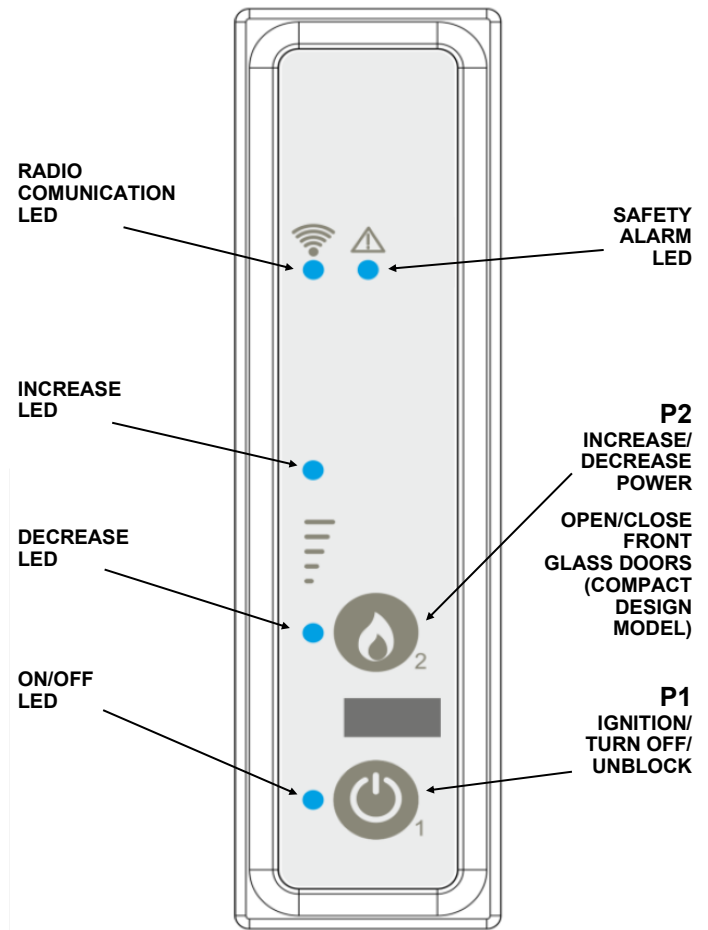

Button	Description	Mode	Function
P1	ON/OFF	WORK	If pressed for more than 2 seconds the stove turns on or turns off if it was already on
	Unblock	BLOCK	If pressed for more than 2 seconds the safety alarms are reset
P2	Decrease Temperature/ Power	WORK	Increases or decreases the value of the set power level
	Open/Close Front Glass Doors	OFF	COMPACT DESIGN MODEL Pressed for 5 seconds opens or closes the front glass doors

DISPLAY

Introduction

The display shows information about the operating status of the stove. By accessing the menu, various types of views can be obtained and available settings can be adjusted depending on the access level. Depending on the operating mode, the display views may have different meanings based on their position on the screen.

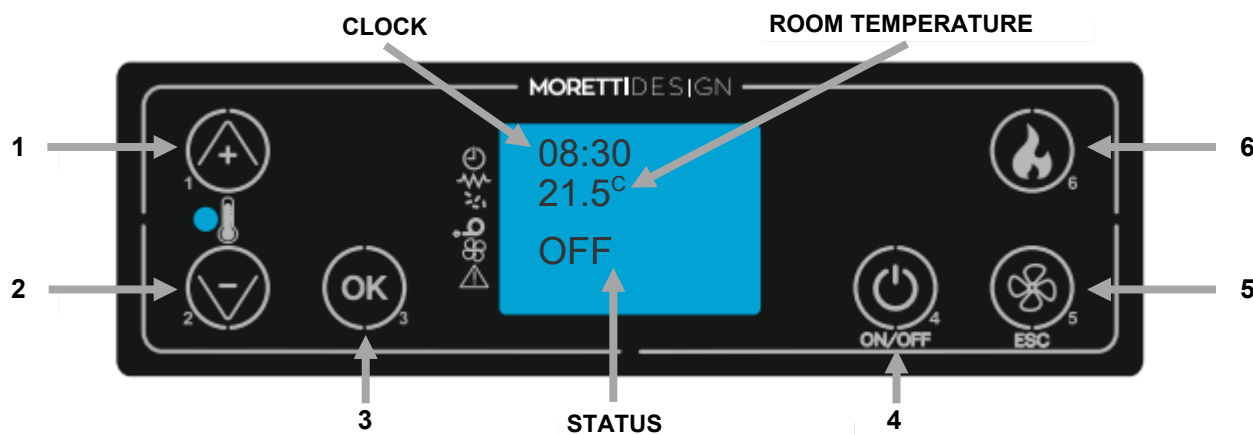

Button description

Button	Description	Mode	Function
1	Increase Temperature/Power	PROGRAM	Change/increase value in the selected menu
		WORK	Increase set value of the room temperature and power level
2	Decrease Temperature/Power	PROGRAM	Change/decrease value in the selected menu
		WORK	Decrease set value of the room temperature and power level
3	OK	HOME	Accesses the menu
		MENU	Accesses the next level of the sub-menu
		PROGRAM	Sets value and skips to the next item in the menu
4	ON/OFF	WORK	Press button 4 and then 3 to turn the stove on or off
		MENU	Return to the previous menu
		PROGRAM	Set value and return to the upper menu
5	ESC	HOME	Access room fan adjustment
		HOME	Access ducting set (if available)
6	Power	HOME	Access power adjustment

Side symbols

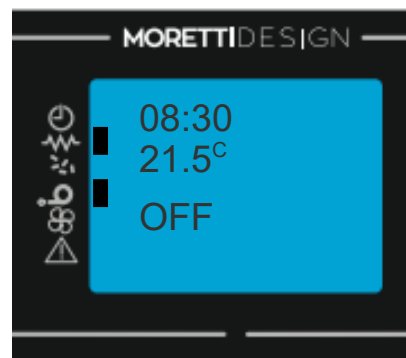

In addition to the buttons, the display shows 6 symbols. If a black indicator appears next to a symbol, it means that the corresponding function or component is active.

Symbol	Description
	Chrono
	Igniter
	Pellet loading
	Smoke extractor
	Room fan
	Error

OPERATING STATUS

Below are described the normal functions of the Remote Control of the stove with a reference to the operations available to the user. The information given below refers to the Remote Control equipped with a programmable thermostat option.

Ignition of the stove

To turn on the stove, press button **4** and confirm with **3**. The ignition starts when the word **CHECK UP** appears on the display. It is then followed by: **PREHEAT - LOAD PELLETT - FLAME WAIT - STABILIZATION**.

Stove in work mode

When the ignition phase has been carried out successfully, the stove switches to the working mode which represents the normal operating mode. The status is indicated on the display with the word **WORK**.

Room temperature setting

Once you enter the **SET ROOM TEMPERAT** menu using button **1** or **2**, to modify the room temperature simply use buttons **1** and **2**, and confirm with **5**. The display shows the current temperature SET status.

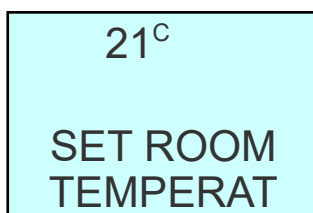

Ducted outlets temperature setting (C Models)

For this operation, see **CONNECTION AND DESCRIPTION ON HOW A DUCTED STOVE OPERATES** on page 7.

Modification of the room fan setting

Once you enter the **REGULATE AIR** menu using button **5**, to modify the speed of the room fan simply use buttons **1** and **2**, and confirm with **5**. When set to off, the room fan remains deactivated. For safety reasons, it automatically reactivates if the combustion power is set to 4 or 5. The display shows the current fan SET status.

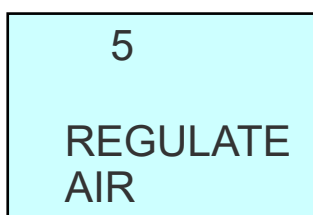

Combustion power setting

Once you enter the **POWER SET** menu using button **6**, to modify the combustion power simply use buttons **1** and **2**, and confirm with **5**. The display shows the current power SET status.

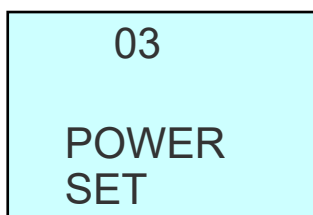

The room temperature reaches the SET temperature

When the room temperature has reached the set value, the combustion is automatically brought to a minimum, Modulation condition. This status is indicated as **MODULATION** on the display (the SET power level remains, but it is automatically set to minimum).

Turning off the stove

To turn off the stove, simply press button **4** and confirm with **3**. The auger immediately stops and the exhaust fan runs at high speed. The status is indicated on the display with the word **FINAL CLEANING**.

When this phase is completed, the exhaust fan stops and the word **OFF** appears on the display.

Note: Turn off the stove in case of failure or malfunction

THE MENUS

To access the menu press the **4** button.

The menu is subdivided into various items that allow you to access settings and programming.

The items in the menu that allow access to technical programming are password protected.

Order	User menu
1	ECO CLIMA
2	CHRONO
3	TIME AND DATE
4	LANGUAGE
5	BUZZER ENABLE
6	INITIAL LOAD
7	ADVANCED MENU
8	FAN MODE
9	MONITOR
10	WIFI STATUS
11	CALIBRATION
12	SYSTEM MENU

Eco clima

Activates the **ECO CLIMA** mode that brings the stove to turn off after the room temperature has remained above the SET temperature plus a delta for a certain amount of time.

The word **ECO-CLIMA** appears on the display (this mode is activated in **MODULATION** once the SET ROOM TEMP has been reached) and will start a timer, which once expired will activate the **STAND-BY** mode and then the stove will start the **FINAL CLEANING**.

After the **FINAL CLEANING** the stove remains in **STAND-BY** waiting for the room temperature to drop below the SET ROOM TEMP + DELTA, in order to restart the ignition.

The **STAND-BY** activates when all the SET ROOM TEMP are reached, while the ignition is only controlled by the temperature of the SET ROOM TEMP.

- Use buttons **1** and **2** to navigate, and press **4** to confirm.

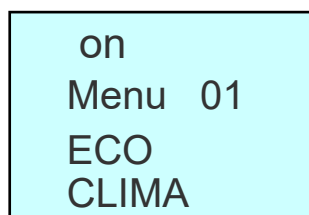

ON

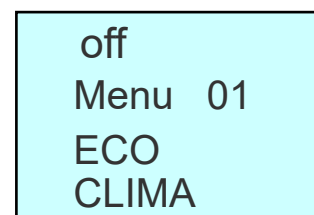

OFF

Chrono

This menu is used for setting the on/off switching time ranges of the stove.

Enable Chrono: Allows you to globally enable or disable all chronothermostat functions. Use buttons 1 and 2 to navigate, and press 4 to confirm.

on
M 2 - 1 - 01
ENABLE
CHRONO

ON

off
M 2 - 1 - 01
ENABLE
CHRONO

OFF

Daily chrono: Allows to enable, disable and set the daily timer thermostat function.

on
M 2 - 2 - 01
DAILY
CHRONO

ON

off
M 2 - 2 - 01
DAILY
CHRONO

OFF

The Day Chrono has 2 independent operating time slots for each individual day. Scroll through the submenus using button 3 and modify **START TIME, STOP TIME, POWER SETTING, and TEMPERATURE SETTING** using buttons 1 and 2. Confirm with button 3. To scroll backward through the submenus, use button 5.

08:00
M 2 - 2 - 02
START 1
DAY

10:00
M 2 - 2 - 03
STOP 1
DAY

03
M 2 - 2 - 92
POT PRG 1
DAY

20^C
M 2 - 2 - 93
AMB PRG 1
DAY

Weekly chrono: Allows to enable, disable and set the weekly timer thermostat function.

on
M 2 - 3 - 01
WEEKLY
CHRONO

ON

off
M 2 - 3 - 01
WEEKLY
CHRONO

OFF

The Weekly Chrono has 4 independent programmable time frames, the final effect of which is the combination of the 4 individual programs.

Scroll through the submenus using button 3 and modify **START TIME, STOP TIME, POWER SETTING, and TEMPERATURE SETTING** using buttons 1 and 2. Confirm with button 3. To scroll backward through the submenus, use button 5.

08:00
M 2 - 3 - 02
START 1
CHRONO

10:00
M 2 - 3 - 03
STOP 1
CHRONO

03
M 2 - 3 - 87
POT PRG 1
CHRONO

20^C
M 2 - 3 - 88
AMB PRG 1
CHRONO

Then select the days of the week in which to activate the previously selected time slot (Slot 1). Select on or off using buttons 1 and 2, and confirm with button 3.

on
M 2 - 3 - 04
MONDAY
PROG - 1

off
M 2 - 3 - 05
TUESDAY
PROG - 1

Chrono weekend: Allows to enable, disable and set the timer thermostat function on weekends (days 6 and 7, Saturday and Sunday).

on
M 2 - 4 - 01
CHRONO
WEEK - END

ON

off
M 2 - 4 - 01
CHRONO
WEEK - END

OFF

The Weekend Chrono has 2 independent operating time slots for each individual day (Saturday and Sunday). Scroll through the submenus using button 3 and modify **START TIME, STOP TIME, POWER SETTING, and TEMPERATURE SETTING** using buttons 1 and 2. Confirm with button 3. To scroll backward through the submenus, use button 5.

Warning: Carefully program the time frames in order to avoid the overlapping of the enabled and /or disabled operating hours of the same day in different programs.

Note: in order to avoid undesired ignitions and turn-offs, it is recommended to activate only one program at a time, namely:

- Deactivate the daily chrono if you want to use the weekly one.
- Always keep the chrono week-end off when you use the weekly chrono in programs 1, 2, 3 and 4.
- Activate chrono week-end only after you have deactivated weekly chrono.

Time and Date

Sets the current date and time.

- Select the day of the week using buttons **1** and **2**; to confirm, press button **3**.
- Select hours, minutes, day, month, and year using buttons **1** and **2**; press button **3** to confirm each entry.

The control unit is equipped with a lithium battery which allows the internal clock to have an autonomy for more than 4/5 years.

Language

It allows you to select the menu language.

- Use the **1** and **2** buttons to select a language from the available ones, press **3** to confirm.

Buzzer Enable

Buzzer mode: Allows you to enable and disable the control unit's feedback sound.

- To enable it use the **1** and **2** buttons, press **4** to confirm.

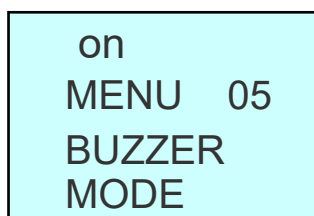

ENABLE

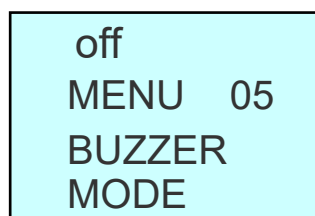

DISABLED

Initial load

With the stove off and cool, the function allows a pellet preload for a time of 90" (seconds).

- To activate press the **1** button, **wait** for the timer to start and stop by pressing the **4** button.

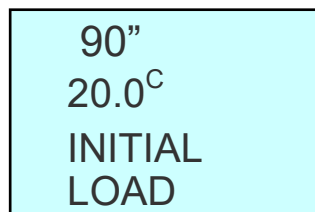
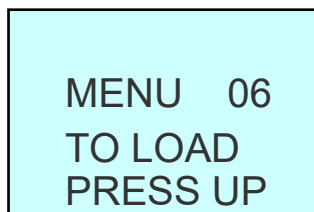

Advanced Menu

WARNING: This menu is reserved for the exclusive use of the technician. Do not change the set values.

Fan mode (only for C models)

It allows to control the ventilation of the ducted outlets in **MANUAL** or **AUTOMATIC**.

- To do so, use the **1** and **2** buttons, press **3** to confirm.

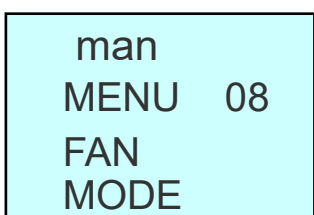

MANUAL

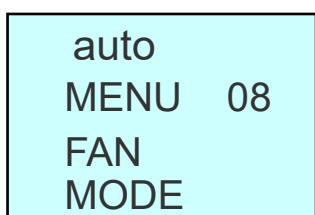

AUTOMATIC

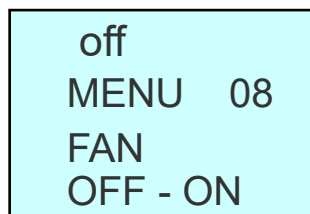

OFF

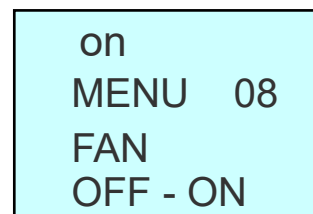

ON

Allows to use the relax mode with installed ducting for HYBRID stoves. Fan deactivation works for the power P1, P2,P3, while the power P4 and P5 the fan works automatically.

See **CONNECTION AND DESCRIPTION ON HOW A DUCTED STOVE OPERATES** on page 7 for further details.

Monitor

Displays a series of operating parameters of the stove.

- To move the cursor in the menu use the **1** and **2** buttons, to exit press the **4** button.

WiFi Status (optional if provided) or LED-MODE(only on models with led)

Enable, Disable and set the Auto function of the led operation

- OFF -- Led always off
- ON -- Led always on
- Auto-- The LEDs will light up when the stove goes on and for the entire period of operation, they will turn off when the state of the stove will switch off.

To make it work use the keys **1** and **2**, to confirm press **4**.

Calibration

This menu allows the adjustment of the combustion parameters.

Type pellet: Menu for changing the operating time of the Auger.

- Press button **3** to edit the values. Use buttons **1** and **2** to increase or decrease the values. To exit, press button **3** again.

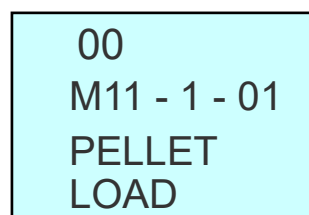

See **COMBUSTION** on page 7 for further details.

System menu

This menu allows to access the Settings technic reserved for Technical Service Centers. The KEY ACCESS is password protected.

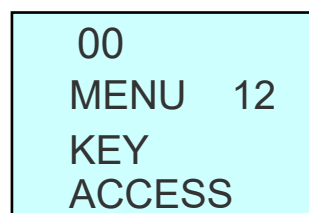

SAFETY ALARMS

Code	Description	Cause	Operations to be performed	Solutions
SIC01 TANK-TEMP OVERHEATING TANK PELLETS	Turn off due to safety thermostat intervention	HEATING FAN BROKEN	Unblock and verify the proper function of the fan	If the fan is broken, contact an authorised technician
		HIGH TEMPERATURE IN PELLETTANK	Unblock and turn on the stove, if the error reoccurs turn off the stove	If the safety alarm persists, contact an authorised technician
		THERMOSTAT BROKEN	Unblock and turn on the stove, if the error occurs immediately, it is likely that the thermostat is broken	
		CONTROL UNIT BROKEN	Unblock and turn on the stove, if the error occurs immediately, it is likely that the control unit is broken	
SIC02 NO DEPRESSURE NO DEPRESSION IN THE CHIMNEY	Turn off due to chimney flue occlusion	CHIMNEY FLUE OCCLUDED	Unblock and check, if you need to clean your chimney flue	If the safety alarm persists, contact an authorised technician
		WIND IN THE CHIMNEY FLUE	Unblock and check if the flue needs to be installed according to standard regulations and directions contained in this manual	
		PRESSURE SWITCH BROKEN	Unblock and turn on the stove, if the error occurs immediately, it is likely that the pressure switch is broken	
		CONTROL UNIT BROKEN	Unblock and turn on the stove, if the error occurs immediately, it is likely that the control unit is broken	
SIC02 DRAW INSUFF-	Turn off due to a blocked air intake or lack of minimum combustion air	FLUX ANOMALY READ BY THE FCS	Unblock and check / clean the local air intake located on the back of the stove	If the safety alarm persists, contact an authorised technician
SIC03 CHECK PELLETS CHECK PELLETS LOW SMOKE TEMPERATURE	Turn off due to low fume temperature	PELLET TANK EMPTY	Unblock and check if there are any pellets in the tank	Refill pellet tank
		BLOCKED AUGER	Unblock, clean burner and turn the stove on again	If the safety alarm persists, contact an authorised technician
		AUGER MOTOR BROKEN		
		EXHAUST FUME SENSOR BROKEN		
SIC05 TEMP. SMOKE SMOKE TEMPERATURE TOO HIGH	Turn off due to high smoke temperature	DIRTY STOVE	Unblock and turn on the stove, if the error reoccurs, the stove probably needs to be cleaned	If the safety alarm persists, contact an authorised technician
		EXHAUST FUME SENSOR BROKEN	If the fume temperature is high even during the shutdown phase, thermocouple is broken	
SIC07 NO ENCODER NO ENCODER SMOKE EXTRACTOR	Turn off due to Encoder error	NO SIGNAL TO ENCODER	Unblock and turn on the stove, if the error reoccurs, then the exhaust fan or control unit is broken	If the safety alarm persists, contact an authorised technician
SIC08 REG. ENCODER CHECK ENCODER SMOKE EXTRACTOR	Turn off due to Encoder error	NON SETTING ENCODER	Unblock and turn on the stove, if the error reoccurs, then the exhaust fan or control unit is broken	If the safety alarm persists, contact an authorised technician

Code	Description	Cause	Operations to be performed	Solutions
SIC11	Turn off due to clock error or flat battery in the control unit	CLOCK ERROR	Reset the time and date (page 13) and then unblock	If the safety alarm persists, contact an authorised technician
		FLAT BATTERY IN THE CONTROL UNIT	Turn off the main switch, replace the battery on the control unit, reset the time and date (page 13) and then unblock	If the safety alarm persists, contact an authorised technician
SIC12 FAILED IGNITION FAILURE IGNITION CLEAN BRAZIER	Turn off due to ignition failure	EMPTY PELLET TANK	Unblock and check if there are any pellets in the tank	Refill pellet tank
		IGNITION RESISTANCE BROKEN	Unblock, clean the burner then turn on, if the following ignitions are not successful then the ignition resistance must be replaced	If the safety alarm persists, contact an authorised technician
		DIRTY BURNER	Unblock, clean burner then turn on again	Clean burner
SIC15 BLACKOUT BLACKOUT POWER SUPPLY	Turn off due to power failure	BLACKOUT	Power failure	If the safety alarm persists, contact an authorised technician
SIC25 CLEANER BROKEN BRAZIER BLOCK CLEAN AND TURN ON	Turn off due to anomaly in burner cleaning system CLEAN MODELS	ANOMALY IN THE AUTOMATIC BURNER CLEANING SYSTEM	Unblock, turn off the main switch and check if there are obstructions that prevent the movement of the burner base during the cleaning phase	If the safety alarm persists, contact an authorised technician
SIC25 CLEANER BROKEN	Turn off due to anomaly in front glass doors opening System COMPACT GLASS	ANOMALY IN THE AUTOMATIC FRONT GLASS DOOR OPENING SYSTEM	Unblock, turn off the main switch and check if there are obstructions that prevent the movement of the front glass doors	If the safety alarm persists, contact an authorised technician
SIC39 NO FLOW FCS SENSOR	Measuring anomaly	FCS BROKEN	Unblock, clean burner and turn the stove on again	If the safety alarm persists, contact an authorised technician
SIC44 DOOR SENSOR DOOR SENSOR OPEN SEE MICRO	Micro switch intervention	FRONT AND/OR PELLET TANK DOOR OPEN FOR MORE THAN 120 SECONDS	Unblock and check if the front and/or pellet tank door are closed properly	If the safety alarm persists, contact an authorised technician
END SERVICE	Acoustic alarm	MESSAGE THAT INDICATES THE ACHIEVEMENT OF THE SCHEDULED FUNCTIONING HOURS	The stove is in need of an extraordinary maintenance and service procedure that must be carried out by an authorised technician	Contact an authorised technician
DEVICE NOT FOUND	No transmission between remote control and control unit	NO TRANSMISSION BETWEEN REMOTE CONTROL AND CONTROL UNIT	Carry out the Remote control channel change procedure (page 11) and verify if with a new channel the remote control can transmit signals to the stove	If the message persists, contact an authorised technician
DOOR	The auger stops and the exhaust fan turns at maximum speed	FRONT DOOR OPEN WITHIN 120 SECONDS	Check if the front door is closed properly	If the message persists, contact an authorised technician
Recovery start	Request for the stove to be switched on during the final cleaning phase	REQUEST TO BE SWITCHED ON DURING THE FINAL CLEANING PHASE	Wait for the restart, if you want to disable repeat the ignition procedure	If the message persists, contact an authorised technician

CONTROL UNIT - COMPACT GLASS A/C, SLOT GLASS A/C, SLOT REMOTE AIR

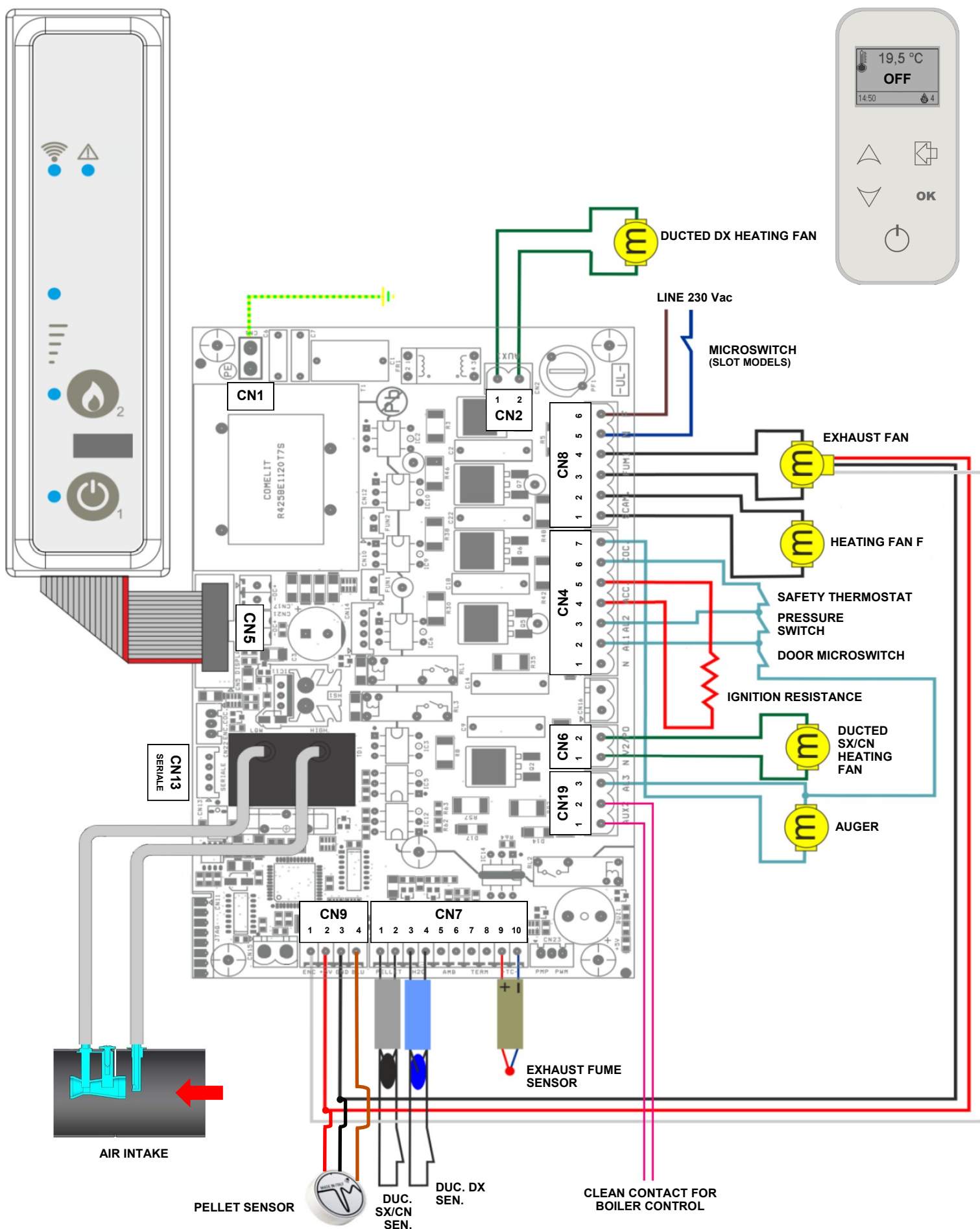

Connector	Pin	label	Function
CN1	-	PE	Ground
CN2	1 - 2	AUX 1	Ducted DX Heating Fan
CN4	1	N	Neutral
	2	AL1	Pressure Switch
	3	AL2	Safety Thermostat
	4 - 5	ACC	Ignition Resistance
	6	COC	Phase Auger
	7	COC	Neutral Auger
CN5	-	DISPLAY	Receiver
CN6	1 - 2	V2/PO	Ducted SX/CN Heating Fan
CN7	1 - 2	PELLET	Thermostat or Ducted SX/CN Sensor
	3 - 4	H2O	Thermostat or Ducted DX Sensor
	5 - 6	AMB	-
	7 - 8	TERM	-
	9 - 10	-TC+	Exhaust Fume Sensor
CN8	1 - 2	SCAM	Heating Fan F
	3 - 4	FUMI	Exhaust Fan
	5	N	Neutral
	6	F	Phase
CN9	1	ENC	White Encoder Exhaust Fan
	2	+5V	Red Encoder Exhaust Fan
	3	GND	Black Encoder Exhaust Fan
	4	BLU	-
CN13	-	SERIAL	Serial for Programmer
CN19	1 - 2	AUX 2	Auxiliary output
	3	AL3	Door Microswitch

CONTROL UNIT - SAT GLASS A, GLOBE GLASS A/C

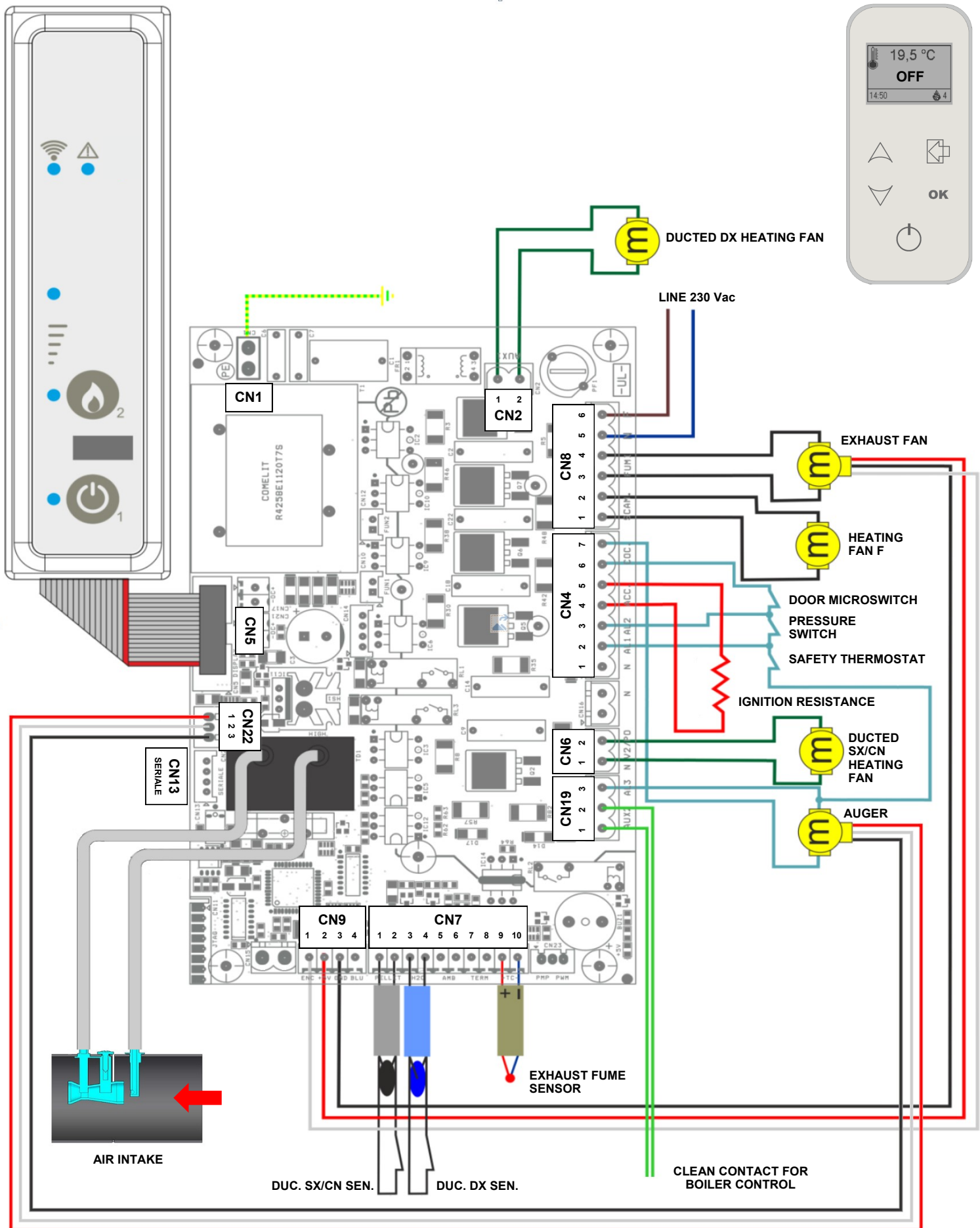

Connector	Pin	label	Function
CN1	-	PE	Ground
CN2	1 - 2	AUX 1	Ducted DX Heating Fan
CN4	1	N	Neutral
	2	AL1	Pressure Switch
	3	AL2	Door Microswitch
	4 - 5	ACC	Ignition Resistance
	6	COC	Phase Auger
	7	COC	Neutral Auger
CN5	-	DISPLAY	Receiver
CN6	1 - 2	V2/PO	Ducted SX/CN Heating Fan
CN7	1 - 2	PELLET	Thermostat or Ducted SX/CN Sensor
	3 - 4	H2O	Thermostat or Ducted DX Sensor
	5 - 6	AMB	-
	7 - 8	TERM	-
	9 - 10	-TC+	Exhaust Fume Sensor
CN8	1 - 2	SCAM	Heating Fan F
	3 - 4	FUMI	Exhaust Fan
	5	N	Neutral
	6	F	Phase
CN9	1	ENC	White Encoder Exhaust Fan
	2	+5V	Red Encoder Exhaust Fan
	3	GND	Black Encoder Exhaust Fan
	4	BLU	-
CN13	-	SERIAL	Serial for Programmer
CN19	1 - 2	AUX 2	Auxiliary output
	3	AL3	Safety Thermostat
CN22	1 - 2 - 3	ENC COC	Auger Encoder

CONTROL UNIT - RELAX CLEAN, COMPACT DESIGN A/C, 9, 11, 13 KW MODELS A/C CLEAN, COMPACT HYBRID

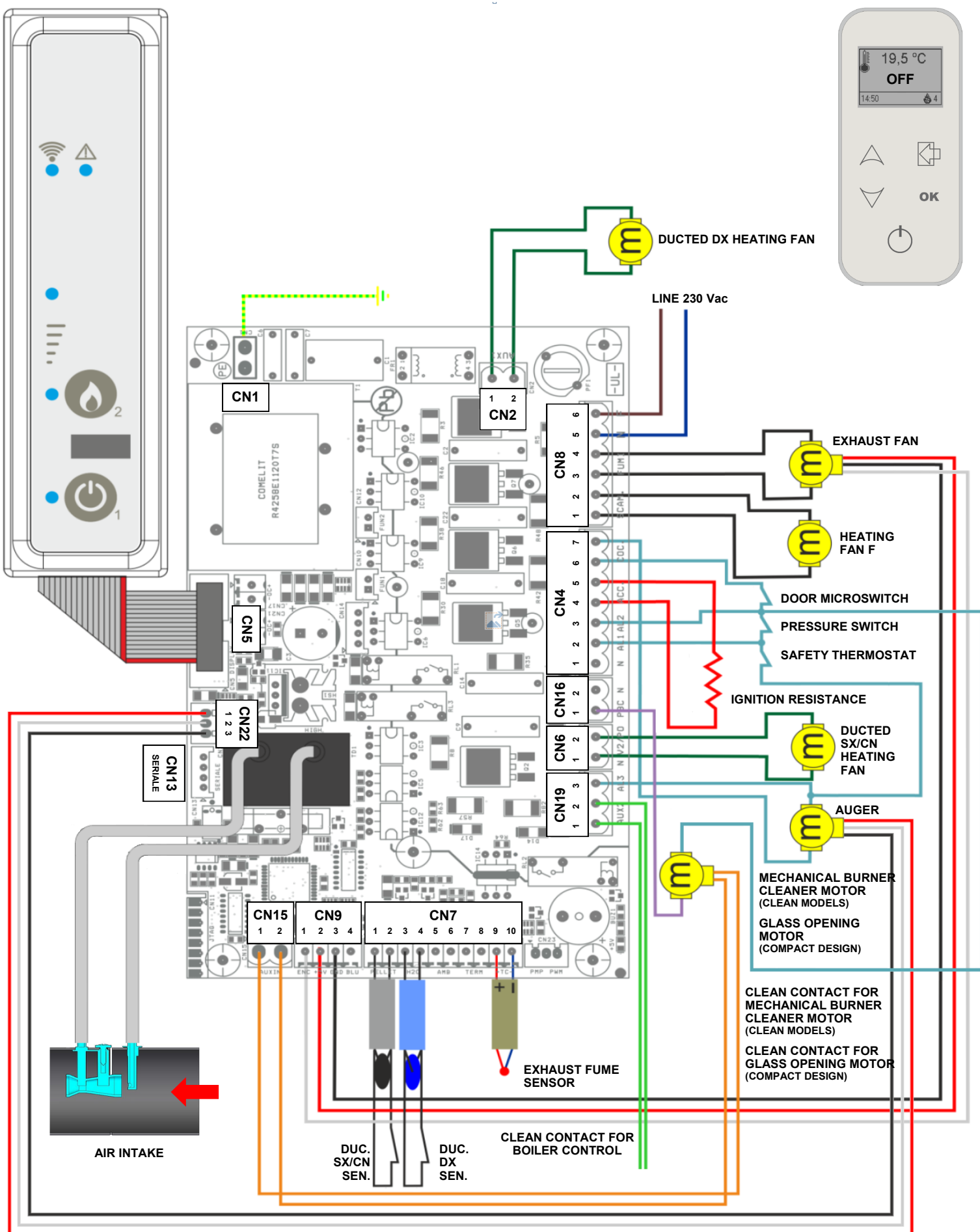

Connector	Pin	label	Function
CN1	-	PE	Ground
CN2	1 - 2	AUX 1	Ducted DX Heating Fan
CN4	1	N	Neutral
	2	AL1	Pressure Switch
	3	AL2	Door Microswitch
	4 - 5	ACC	Ignition Resistance
	6	COC	Phase Auger
	7	COC	Neutral Auger
CN5	-	DISPLAY	Receiver
CN6	1 - 2	V2/PO	Ducted SX/CN Heating Fan
CN7	1 - 2	PELLET	Thermostat or Ducted SX/CN Sensor
	3 - 4	H2O	Thermostat or Ducted DX Sensor
	5 - 6	AMB	-
	7 - 8	TERM	-
	9 - 10	-TC+	Exhaust Fume Sensor
CN8	1 - 2	SCAM	Heating Fan F
	3 - 4	FUMI	Exhaust Fan
	5	N	Neutral
	6	F	Phase
CN9	1	ENC	White Encoder Exhaust Fan
	2	+5V	Red Encoder Exhaust Fan
	3	GND	Black Encoder Exhaust Fan
	4	BLU	-
CN13	-	SERIAL	Serial for Programmer
CN15	1 - 2	AUX IN	Clean Contact Mechanical Burner Cleaner Motor (CLEAN MODELS) Clean Contact Front Glass Opening Motor (COMPACT DESIGN)
CN16	1	PBC	Mechanical Cleaner Phase (CLEAN MODELS) Front Glass Opening Motor Phase (COMPACT DESIGN)
CN19	1 - 2	AUX 2	Auxiliary output
	3	AL3	Safety Thermostat
CN22	1 - 2 - 3	ENC COC	Auger Encoder

CONTROL UNIT - DREAM, DOLBY

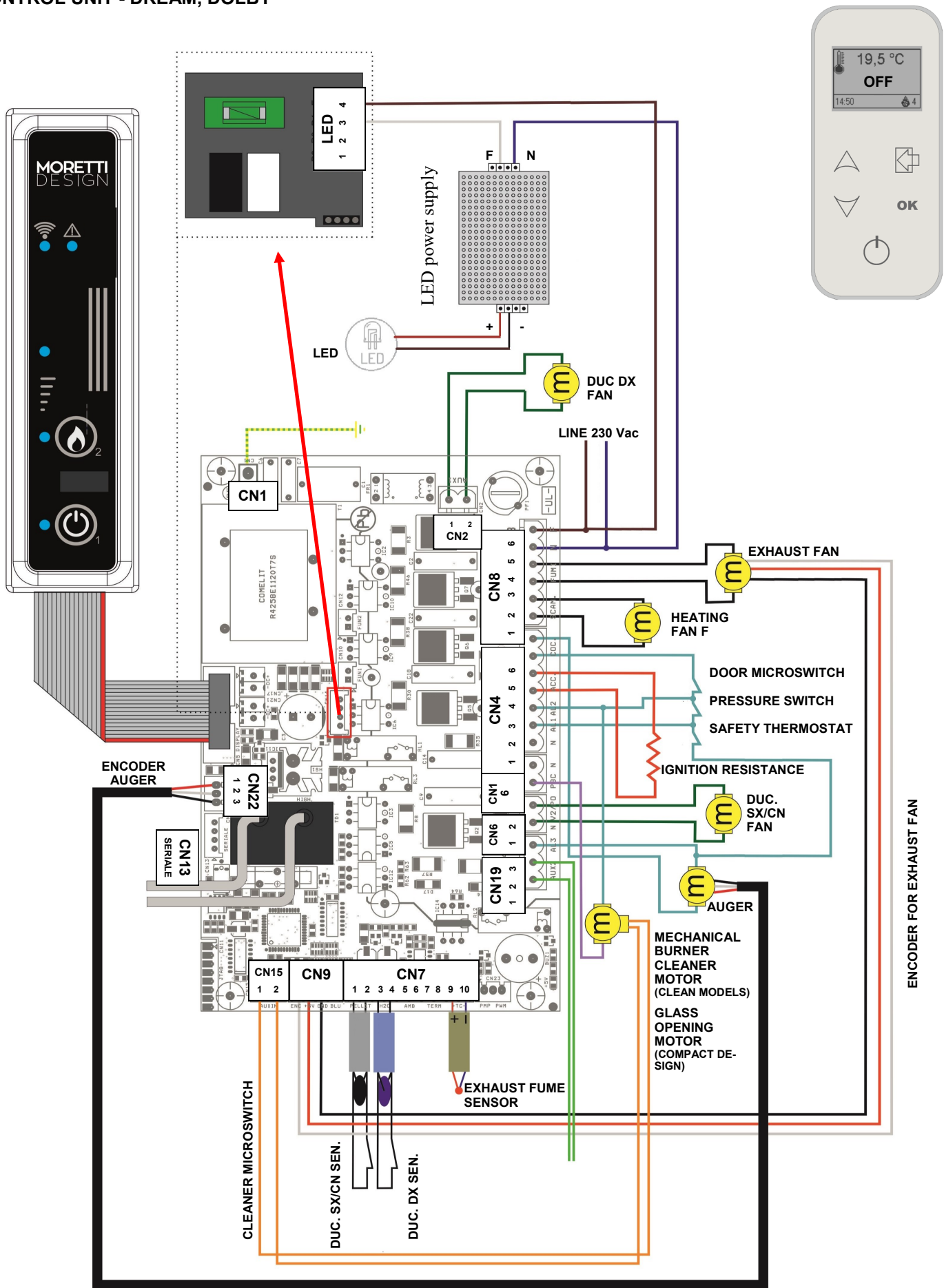

Connector	Pin	label	Function
CN1	-	PE	Ground
CN2	1 - 2	AUX 1	Ducted DX Heating Fan
CN4	1	N	Neutral
	2	AL1	Pressure Switch
	3	AL2	Door Microswitch
	4 - 5	ACC	Ignition Resistance
	6	COC	Phase Auger
	7	COC	Neutral Auger
CN5	-	DISPLAY	Receiver
CN6	1 - 2	V2/PO	Ducted SX/CN Heating Fan
CN7	1 - 2	PELLET	Thermostat or Ducted SX/CN Sensor
	3 - 4	H20	Thermostat or Ducted DX Sensor
	5 - 6	AMB	-
	7 - 8	TERM	-
	9 - 10	-TC+	Exhaust Fume Sensor
CN8	1 - 2	SCAM	Heating Fan F
	3 - 4	FUMI	Exhaust Fan
	5	N	Neutral
	6	F	Phase
CN9	1	ENC	White Encoder Exhaust Fan
	2	+5V	Red Encoder Exhaust Fan
	3	GND	Black Encoder Exhaust Fan
	4	BLU	-
CN13	-	SERIAL	Serial for Programming
CN15	1 - 2	AUX IN	Clean Contact Mechanical Burner Cleaner Motor (CLEAN MODELS) Clean Contact Front Glass Opening Motor (COMPACT DESIGN)
CN16	1	PBC	Mechanical Cleaner Phase (CLEAN MODELS) Front Glass Opening Motor Phase (COMPACT DESIGN)
CN19	1 - 2	AUX 2	Auxiliary Output
	3	AL3	Safety Thermostat
CN22	1 - 2 - 3	ENC COC	Auger Encoder
LED	1	P2	-
	2	P3	-
	3	P4	Phase
	4	F	Phase

CONTROL UNIT - KUBIC, BIJOUX

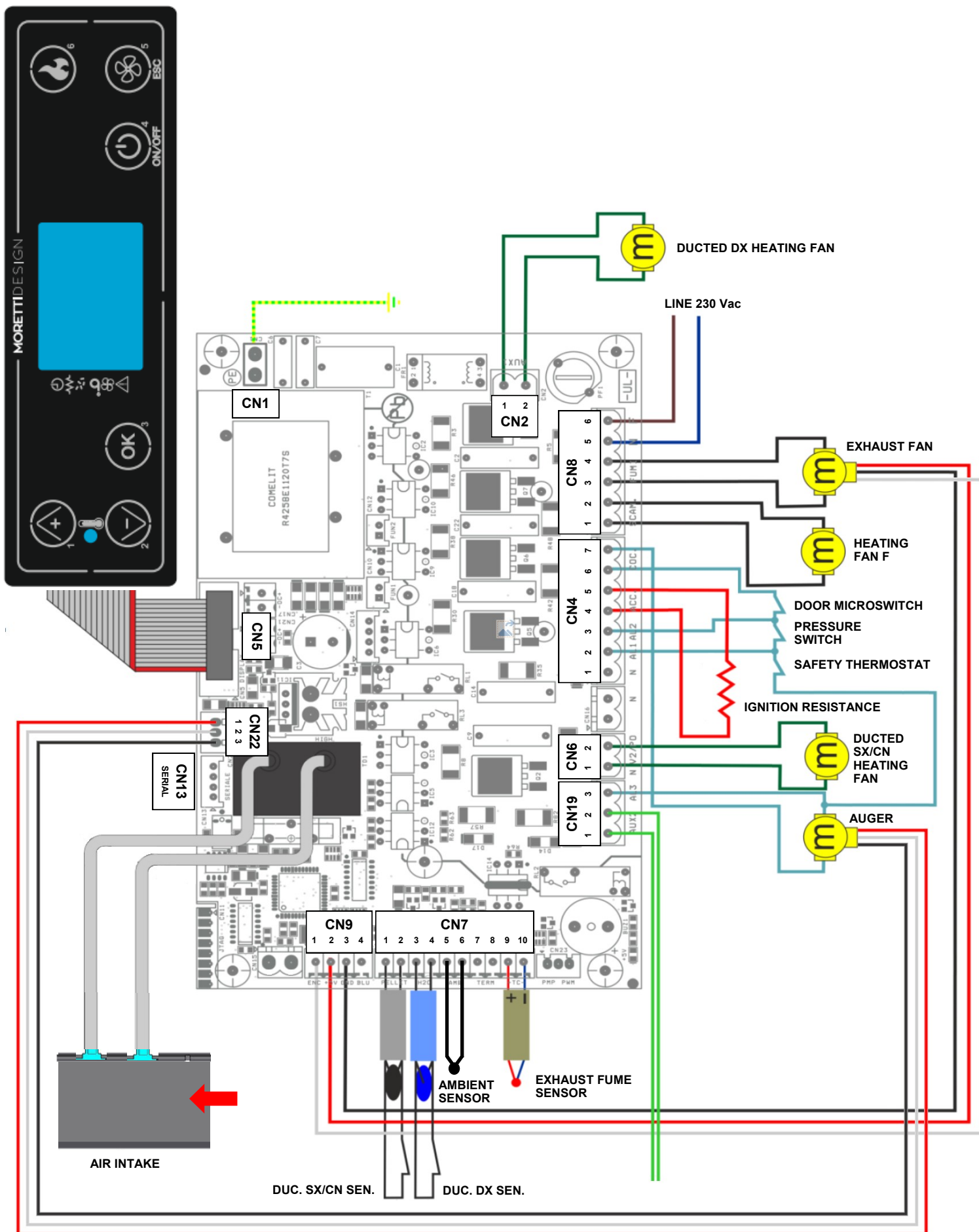

Connector	Pin	label	Function
CN1	-	PE	Ground
CN2	1 - 2	AUX 1	Ducted DX Heating Fan
CN4	1	N	Neutral
	2	AL1	Pressure Switch
	3	AL2	Door Microswitch
	4 - 5	ACC	Ignition Resistance
	6	COC	Phase Auger
	7	COC	Neutral Auger
CN5	-	DISPLAY	Receiver
CN6	1 - 2	V2/PO	Ducted SX/CN Heating Fan
CN7	1 - 2	PELLET	Thermostat or Ducted SX/CN Sensor
	3 - 4	H2O	Thermostat or Ducted DX Sensor
	5 - 6	AMB	Ambient Sensor
	7 - 8	TERM	-
	9 - 10	-TC+	Exhaust Fume Sensor
CN8	1 - 2	SCAM	Heating Fan F
	3 - 4	FUMI	Exhaust Fan
	5	N	Neutral
	6	F	Phase
CN9	1	ENC	White Encoder Exhaust Fan
	2	+5V	Red Encoder Exhaust Fan
	3	GND	Black Encoder Exhaust Fan
	4	BLU	-
CN13	-	SERIAL	Serial for Programmer
CN19	1 - 2	AUX 2	
	3	AL3	Safety Thermostat
CN22	1 - 2 - 3	ENC COC	Auger Encoder

- WI-FI NAVEL 2.0 (Optional) e NAVEL INSIDE (As standard)



Navel 2.0 (Optional)



Navel Inside (As standard)

For the configuration of stoves equipped with a Wi-Fi module, it is necessary to download the **Moretti Design** application, register your own credentials and wait for the confirmation email. Subsequently, launch the application and follow step by step the configuration procedure through the **Moretti Design** application. Once access is made with the created credentials, add the device by entering the serial number of the stove, the MAC code and the Reg. Code. The MAC and Reg. Code are found inside the box of the Navel 2.0 module (Wi-Fi Optional), or in the white box supplied with the stove in the case of the Navel Inside (Wi-Fi as standard). After entering the data, it is necessary to select the correct item code: "Moretti 2023" if the serial number starts with the number 5 or higher, or "Moretti" if it starts with 4 or lower. Finally, activate Bluetooth on the phone and configure the network by selecting the home Wi-Fi network.

MAINTENANCE

Before performing any maintenance procedures on the stove, follow these precautions:

- Wait until all parts of the stove are cold.
- Wait until the ashes are completely off.
- Make sure that the switch is in the "0" position.
- Make sure that the power cable has been disconnected from the main power supply.

PLEASE FOLLOW CAREFULLY THE FOLLOWING CLEANING INSTRUCTIONS!

MORETTI DESIGN IS NOT RESPONSIBLE FOR DAMAGE TO PEOPLE, ANIMALS OR THINGS CAUSED BY A NON-COMPLIANCE OF THE FOLLOWING INDICATIONS.

In addition to the annual extraordinary maintenance and service procedure that must be carried out by authorized personnel, frequent cleaning procedures such as cleaning the burner, emptying the ash drawer and cleaning the tube bundle should be carried out.

Cleaning the burner

To be performed before each ignition, it is necessary to check if the burner is clean, that there are no combustion residuals or if the air ports are not obstructed. All this to avoid that the heater does not perform a poor combustion and to avoid overheating which could cause damage to the stove's painted surfaces or a failed ignition of the flame. The amount of ashes left over in the burner depends on the type of pellet used, even the same type of fuel from different bags of the same brand can have different outcomes when burnt.

Automatic burner cleaner



The CLEAN models are equipped with an automatic burner cleaning system that activates during the first phase of the ignition of the stove.

WARNING: It is recommended to clean the brazier at every alarm SIC03, SIC12, and SIC25. It is also advisable to clean the brazier periodically

Emptying the ash drawer



The ash drawer is located inside the combustion chamber. To access it, open the door, pull the drawer out and then vacuum all ash deposits. This operation must be done daily.

Cleaning the tube bundle (see dedicated manual)



The cleaners can be accessed through the handle, that must be moved according to the direction the arrows are pointing, repeatedly at least four times. During the operation you will notice a small amount of dust/ash falling from the top of the combustion chamber. This operation must be performed weekly.

Cleaning the pellet tank

Monthly empty the pellet tank and vacuum all pellet dust residuals deposited at the bottom.

FireWall



The combustion chamber is lined with Firewall. This vermiculite based material developed by MORETTI DESIGN allows to improve the quality of the combustion due to its heat resistance, light weight and good insulation capacity. The Firewall and the flame tend to become more clearer during the combustion, when it is optimal. When the combustion is not optimal, the Firewall tends to get dirty and assumes a more darker colour.

For the Firewall's maintenance a brush should be used to dust the ashes off. Do not use abrasive, wet or damp materials to clean the Firewall as they may damage or weaken it. Do not use a vacuum cleaner. When removing the Firewall, handle with care. If the stove has been running for several hours, the Firewall might present slight abrasions on its surface, this effect is quite normal because the combustion can create micro-dents on the surface, anyway this doesn't influence negatively the integrity of the Firewall.

Cleaning the surfaces

Use a rag soaked with water for cleaning the painted metal surfaces. The use of detergents or aggressive diluents can damage the stove's surfaces.

To ensure that the stove always has an optimal combustion and to avoid malfunctions, frequent cleaning operations must be carried out. The frequency of these operations may vary according to the time of use of the stove and quality of the pellets.

An overall accurate maintenance check up of the stove must be carried out annually, and this must be performed by a qualified technician. The stove must be kept in such a way as to preserve conditions that ensure safety and efficiency.

WARRANTY CONDITIONS

Warranty certification

Thanking you for choosing our product, MORETTI DESIGN invites you to consult the user manual and to read the following warranty conditions. The manufacturer provides the customer with a 24 month period warranty over the product, that starts from the date of purchase.

Warranty conditions

The warranty is limited and only covers manufacturing defects.

Components not covered by warranty:

- Glass
- Firewall
- Seals
- Majolica
- The burner
- Paint
- Ignition resistance*

*The ignition resistance is covered by a **6-month warranty from the date of purchase of the product on which it is installed**, provided that the first start-up and commissioning have been carried out by a qualified technician.

The warranty does not cover damage caused by:

No first ignition and testing procedure carried out by a qualified technical assistance centre (**expense on the client's behalf**).

Installation performed by non professional personnel and not in compliance with standard regulations or used in a different manner than that it was designed for.

Electrical overloads caused by lightening or non conformed electrical sockets.

Transport and tampering by unauthorized personnel.

The non application at least once a year of cleaning and routine maintenance procedures of the product by a qualified authorized service (**expense on the client's behalf**).

The use of cheap/poor quality fuel or any other material that can damage the product.

Any damage caused by an improper installation and/or disattention of the user.

The following interventions are not considered under warranty:

Interventions to adjust combustion parameters.

Interventions to repair damaged parts caused by poor maintenance.

EXCLUSION OF LIABILITY

Failure to comply with the operating conditions and decadence of the warranty will result in the exclusion of the manufacturer from all liability for any damage to the customer to animals and other people.

MORETTI DESIGN

Moretti Design
ITALY
www.morettidesign.it

The Moretti Design assumes no responsibility for any errors in this manual and the right to modify without notice features of its products