

MORETTI DESIGN

ALADINO
CLESSIDRA
ELEGANCE
ERGONOMIC
DOLBY
HARMONY
PRESTIGE
EXCLUSIVE
TURBO TOP
TURBO GLASS
TURBO COMPACT
COMPACT GLASS
VISION
SLOT VISION
SLOT GLASS
TECNICA FOR HOME
TECNICA GLASS
TECNICA GLASS SHORT
TECNICA EXCLUSIVE
TECNICA COMPACT

AQUA

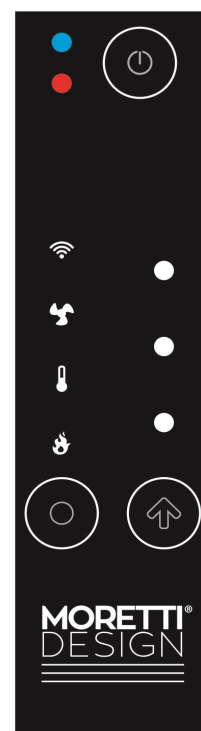
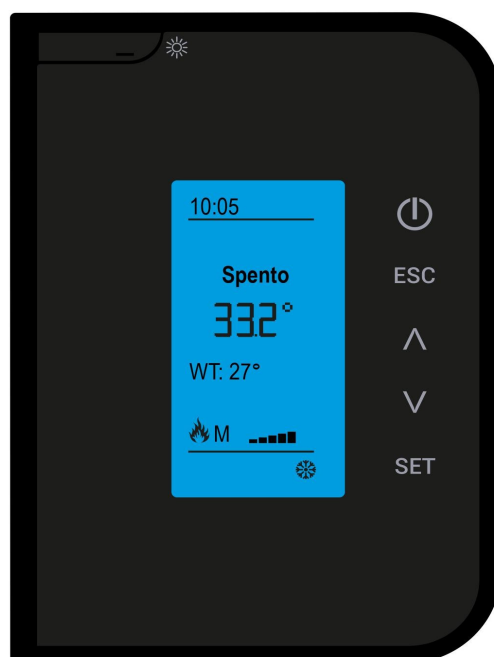
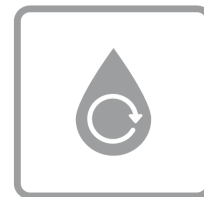

AQUA USER MANUAL

Installation, use and maintenance

INDEX			
INTRODUCTION	2	Thermostat	19
General safety warnings	2	Chrono	20
DESCRIPTION	2	Settings	20
Identification	2	Radio-Thermostat	21
Description of the stove	3	Radio-Standby	21
INSTALLATION	3	Summer-Winter	21
Supply conditions and unpacking	3	Temperature scale	21
Assembling	3	Set Contrast	21
Combustion air	3	Key Tone	21
Fume exhaust	3	Date and time	22
Installation examples	3	Language	22
Installing the remote thermostat in the environment	5	Service	22
Filling the heating system	5	Counters	22
Connecting to a system with zone valves	6	Error List	22
Hot water production kit (optional)	6	WiKey Thermostat	22
Long-term non-use conditions	6	Secondary Informations	22
Operating conditions	6	Radio Test	22
Residual risks	6	Change Code	23
SAFETY DEVICES	6	Cleaning System Reset	23
MINIMUM SAFETY DISTANCES	6	Auger Calibration	23
FIRST IGNITION	6	Fan Calibration	23
Pellet loading	7	Automatic Power	23
Ignition mode	7	Load	23
OPERATING STATUS	7	Loading Test	23
Check Up	7	System Menu	23
Ignition	7	WIFI CONFIGURATION	24
Normal	7	EMERGENCY CONTROL PANEL - WiKey	24
Modulation	7	Led Value L7,L8, L9	24
Combustion power setting	7	How to change Power heating level	24
COMBUSTION	7	How to change the Room Thermostat value	24
Automatic combustion regulation by FCS	7	How to change combustion power level	24
Calibration	7	ERRORS AND SOLUTIONS	25
FIRE PROTECTION	8	PLUMBING CONFIGURATION	28
TOUCH DISPLAY	9	ELECTRONIC CONTROL UNIT	34
DISPLAY RADIO	18	MAINTENANCE	38
Introduction	18	WARRANTY CONDITIONS	38
Button description	18	Warranty certification	38
OPERATING STATUS	18	Warranty conditions	38
Check Up	19	EXCLUSION OF LIABILITY	38
Ignition	19		
Normal	19		
Modulation	19		
Combustion power setting	19		
THE MENUS	19		
USER MENU	19		
Power	19		

Further information: Consult the dedicated manual of the purchased product

We would like to compliment you on purchasing a MORETTI DESIGN hydro pellet stove heater.

Our products are well advanced in the heating and granular combustion field. The advanced technology used as well as fine detailed design, render our heaters the most performing and reliable for pellet combustion. The high quality of materials used combined with skilled craftsmanship all lead to a product that meets all necessities that range from their aesthetic appearance to functional use as well as rendering the room in which it is installed more luxurious with its refined and clean look and unmistakable warmth that only a flame can give.

PLEASE READ VERY CAREFULLY THE FOLLOWING MANUAL BEFORE INSTALLING AND USING THE PRODUCT.

INTRODUCTION

The boiler hydro stove simply indicated as "hydro stove", has been constructed in a conformed way in accordance with the **EN 16510 directive**, taking in account relevant technical standards, using certified components and performing regularly required check-ups to ensure its safe use and functionality.

The hydro stove is delivered ready to be installed along with its installation, user and maintenance manual and CE declaration. The following manual contains important information that must be followed in order to use the hydro stove in a safe manner. The user must read carefully this manual before operating the stove and must pay attention to all indications and obligations given. The hydro stove has been designed to produce hot air for heating and hot water (by using an optional open expansion vessel circuit system) for domestic needs, by burning wooden pellets in accordance with the limitations given in the manual.

Any use other than the purpose for which the hydro stove was built is prohibited.

General safety warnings

All regulations regarding the installation and use of the hydro stove, including those referring to National and European standards must be complied with.

For a correct functionality, the hydro stove must be installed by qualified personnel in accordance with regulation standards and the instruction manual supplied by the manufacturer.

The hydro stove must be used exclusively for the purpose it was designed for, any responsibility for eventual damage to things, people or animals for an improper use of the product will be held at the user's expense.

Do not use the hydro stove as an incinerator or in any other manner other than that for which it was designed for.

Do not use fuels other than wooden pellets. Do not use liquid fuels.

Do not put pellets directly into the burner. Do not open the door whilst the hydro stove is in function.

For its ordinary function, the user must apply all the indications derived from a thorough reading of the user and maintenance manual, and scrupulously observe the indications and signs located on the hydro stove.

The plug of the power cable must be connected only AFTER the installation and assembly of the appliance has been concluded and must remain accessible afterwards, that is if the device does not have a suitable and accessible double-pole switch.

Before any intervention for maintenance, the hydro stove must be disconnected from any power source. Do not remove any signs or protective casings from the stove.

Pay attention that the power cable does not touch any hot parts of the hydro stove.

Do not turn off the hydro stove by disconnecting the cable from the main power supply.

While the hydro stove is in function, its outer surface can reach high temperatures so be cautious when handling to avoid burns.

The appliance cannot be used by children under the age of 8 and persons with reduced physical, sensory or mental capabilities, or without knowledge or experience required, provided that they are under surveillance or after they have been given instructions on how to safely use the appliance and they understand all hazards inherent to it.

The cleaning and maintenance intended to be performed by the user must not be performed by unsupervised children.

Do not perform any unauthorized modifications to the hydro stove.

Use only original spare parts recommended by the manufacturer.

In the event the chimney flue catches fire, turn the hydro stove off by pressing the turn off button, do not disconnect from the main power supply and contact the local fire department.

The maximum pressure and minimum inlet from the water supply should be: 0,5 bar (50 kPa) min and 1.5 bar (150 kPa) Max.

It is recommended the installation of an anti-condensation valve.

It is recommended the installation of a magnetic dirt separator.

The qualified technician that will install the product, will also assume full responsibility for the final installation and the subsequent functionality of the product. There will be no liability from the manufacturer for the failure to comply with such precautions.

After unpacking the hydro stove, make sure of the integrity of the product and completeness of the contents, in case of non-compliance, contact the dealer from whom the hydro stove was purchased from.

The hydro stove maintenance must be carried out at least once a year by qualified personnel, one must plan in time this operating with the technical service center.

On all MORETTI DESIGN products, at the end of the assembly line a scrupulous check-up followed by a combustion test is carried out. Therefore, we inform the customer that at the delivery of the product it is normal to find traces of combustion, which testify the testing occurred.

DESCRIPTION

Identification

Attached on the back of the hydro stove, there is an identification plate on which the following information is written:

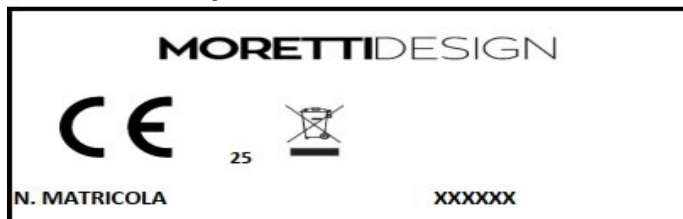

MORETTIDESIGN			
C.da Tesino 50, 63035 Ripatransone (AP) Italia			
MODELLO			
Norma di prodotto	EN 16510-1:2022, EN 16510-2-1:2022		
Designazione apparecchio	RISCALDAMENTO AMBIENTI		
Combustibile ammesso	PELLET DI LEGNO		
P nom	kW	P part	kW
PSH nom	kW	PSH part	kW
PW nom	kW	PW part	kW
η nom	%	η part	%
η_s	%	EEl	-
CO nom	mg/Nm ³	CO part	mg/Nm ³
(13%O ₂)		(13%O ₂)	
NOx nom	mg/Nm ³	NOx part	mg/Nm ³
(13%O ₂)		(13%O ₂)	
OGC nom	mg/Nm ³	OGC part	mg/Nm ³
(13%O ₂)		(13%O ₂)	
PM nom	mg/Nm ³	PM part	mg/Nm ³
(13%O ₂)		(13%O ₂)	
p nom	Pa	p part	Pa
p _w	bar	s	cm
d _R	cm	d _s	cm
d _C	cm	d _p	cm
d _F	cm	d _L	cm
d _B	cm	d non	cm
eI _{S_B}	kW	E,f	V, Hz
eI max	kW	eI min	kW
	-	leggere e seguire le istruzioni per l'uso	
TEST REPORT N.		XXX	
ENTE			

Description of the hydro stove



The pellet hydro stove is a heat source that can heat water, which is then pumped into a closed expansion vessel system, by burning wooden pellets. The fuel is loaded automatically into the hydro stove. The hydro stove has been designed to use a heat transfer fluid (water). The water inside the stove is heated by the flames produced by the combustion of wooden pellets and then pumped into the heating system.

The safe use of the hydro stove is guaranteed by the fact that on all MORETTI DESIGN products, CE certified systems are installed and they control all functions and parameters, including the possible clogging of the chimney flue. The advanced software allows for the user a more simple and immediate comprehension of the hydro stove functions. The presence of a thermostat on all MORETTI DESIGN products allows the user to program the on/off switching function of the hydro stove. The large fuel tank, allows fuel fillings conveniently diluted over time. The large ash draw allows the user to empty it just once a week when it is filled with ash (The frequency of the operation may vary depending on the time of use of the stove and quality of pellets).

INSTALLATION

The hydro stove must be placed on a floor with an adequate load capacity. If the building does not meet this requirement, appropriate measures (e.g. load distribution plate) must be taken.

The installation of the hydro stove must ensure an easy access for cleaning the heater, the flue and the chimney.

The presence of extraction fans in the same room or environment where the appliance is installed in, can cause problems and should therefore be avoided.

It is prohibited to install the stove in a small rooms or bedrooms. It is forbidden to install the stove in rooms exposed to a high risk of fire, in rooms with an explosive atmosphere or where other heat generators are already present whose simultaneous presence is not compatible according to standard regulations. The installation in small rooms or bedrooms can take place only if the stove is hermetic (hermetic system) and air required for the combustion must be drawn directly from the outside through a tube.

All local regulations and European standards must be met when the stove is installed.

Supply conditions and Unpacking

The hydro stove is delivered packaged together with the dismantled aesthetics. To unpack the hydro stove it is necessary to cut the straps and remove the carton. Use the proper equipment for lifting the appliance from the wooden pallet.

Assembling

For the installation of the MORETTI DESIGN hydro stove, contact an authorized technician (the penalty otherwise would be the void of the warranty).

Combustion air



A poor combustion can be caused by poor air circulation in the room and this often occurs in modern homes that have sealed doors and windows. The situation also becomes problematic when, on the contrary, there are air currents inside the room (generated for example by fans). To avoid this type of disadvantage, it is recommended to install a permanent ventilation grid in a window or near the stove.

The air required for the combustion must be drawn directly from the outside through a tube with a **60mm** diameter. The tube must not exceed **5m** in length and must not have more than **4 curves with a 90°** angle. It is recommended the installation of an air grid over the opening and it must be kept clean (see the following example).

If there is no possibility of connecting the air intake directly to the outside (see next paragraph), it is imperative to drill a hole on the wall for the combustion air inlet for both health and safety reasons. It is recommended the installation of an air grid over the opening and it must be kept clean.

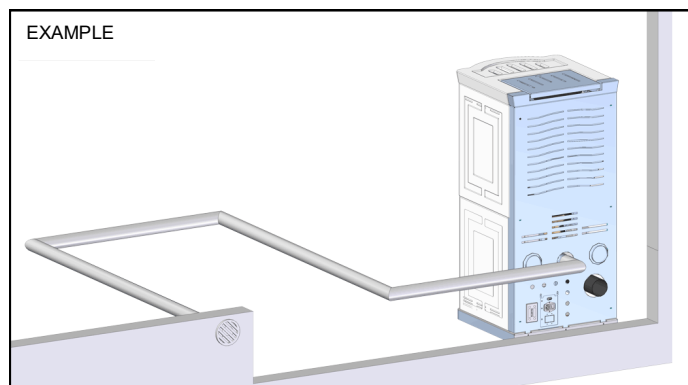

Fume exhaust

To extract the exhaust fumes, a flue must be installed in compliance with standard regulations. The stove was not designed to share the flue with other appliances.

Installation examples

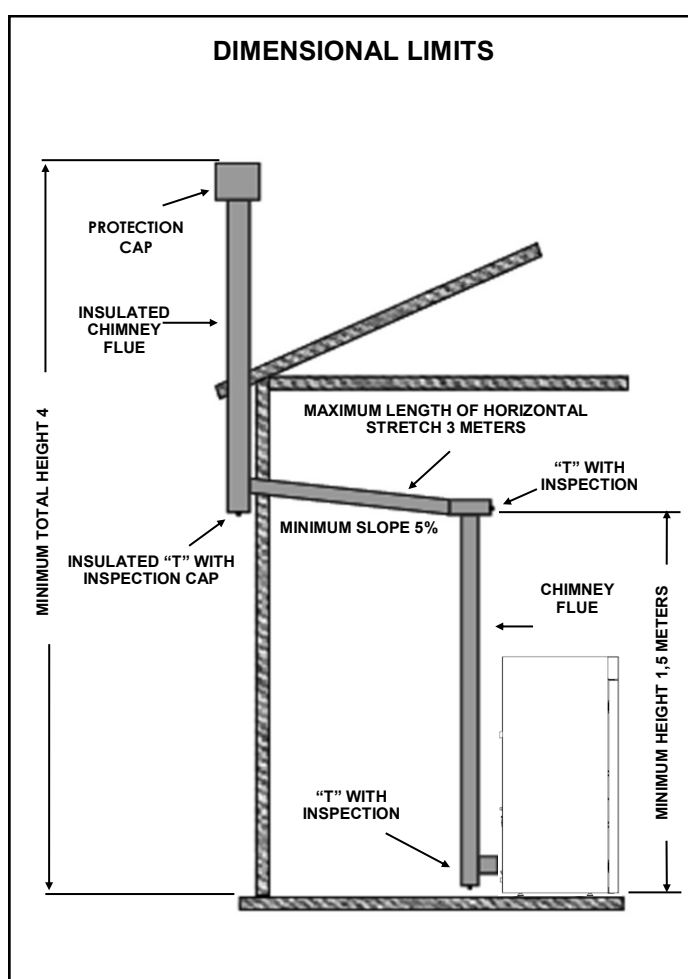

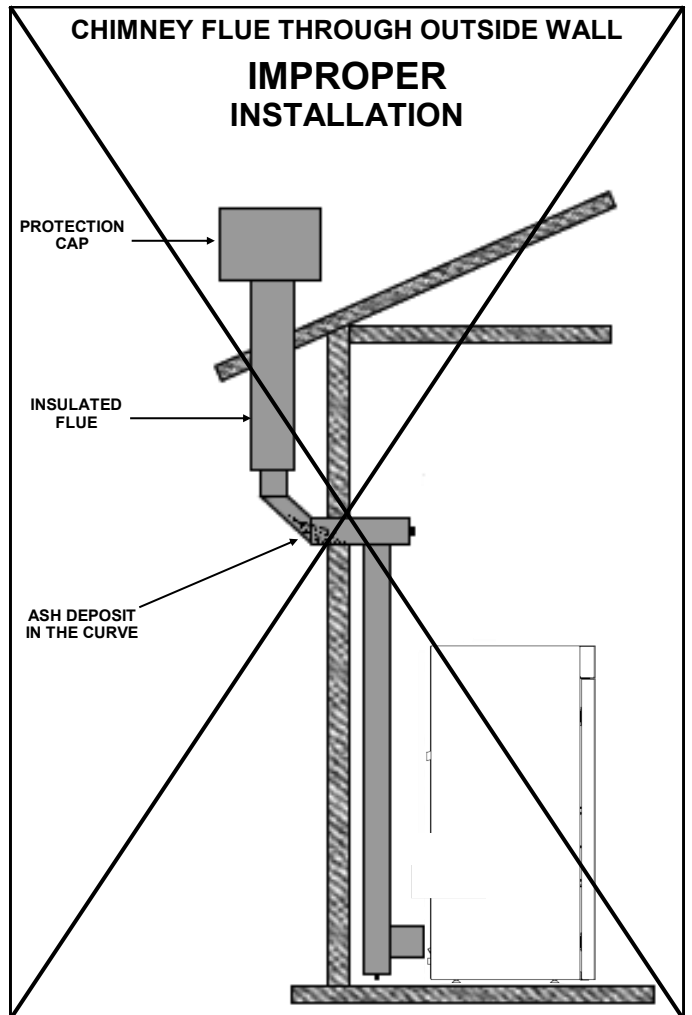
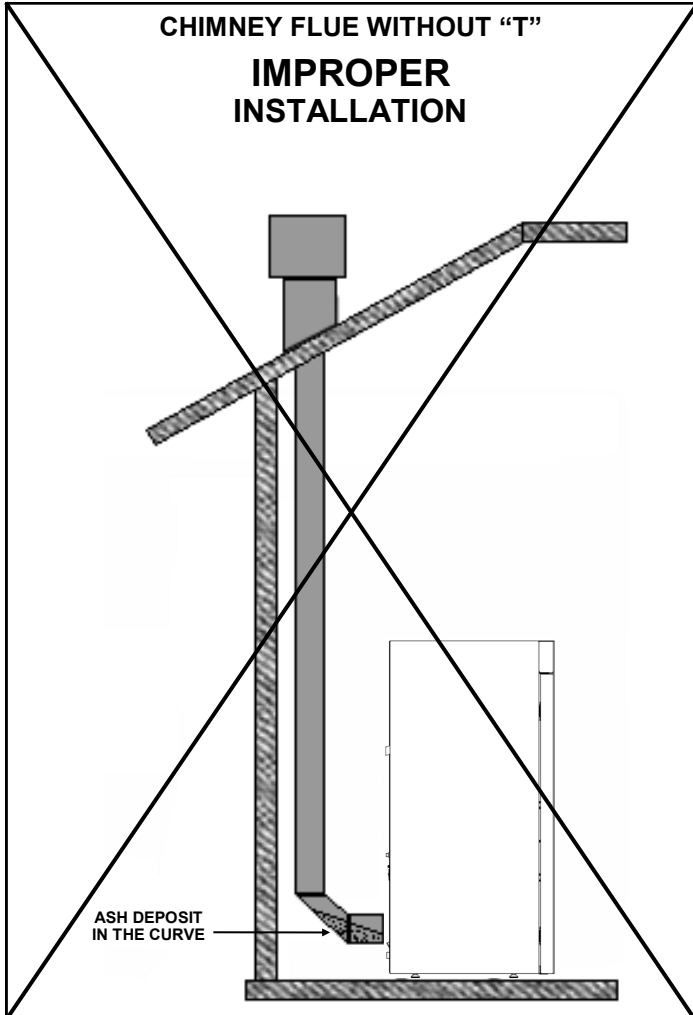
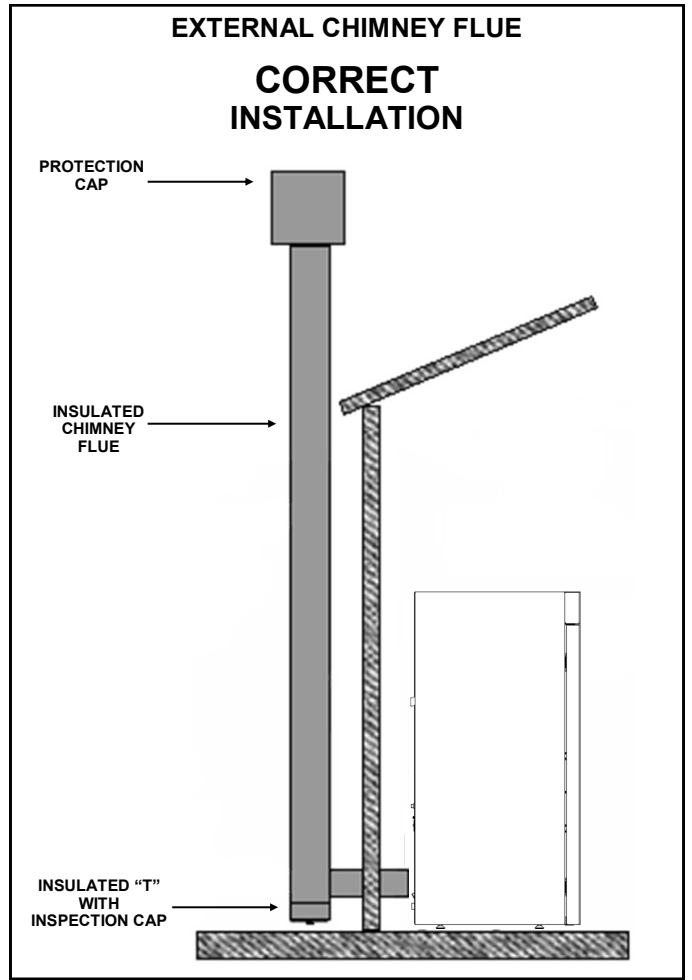
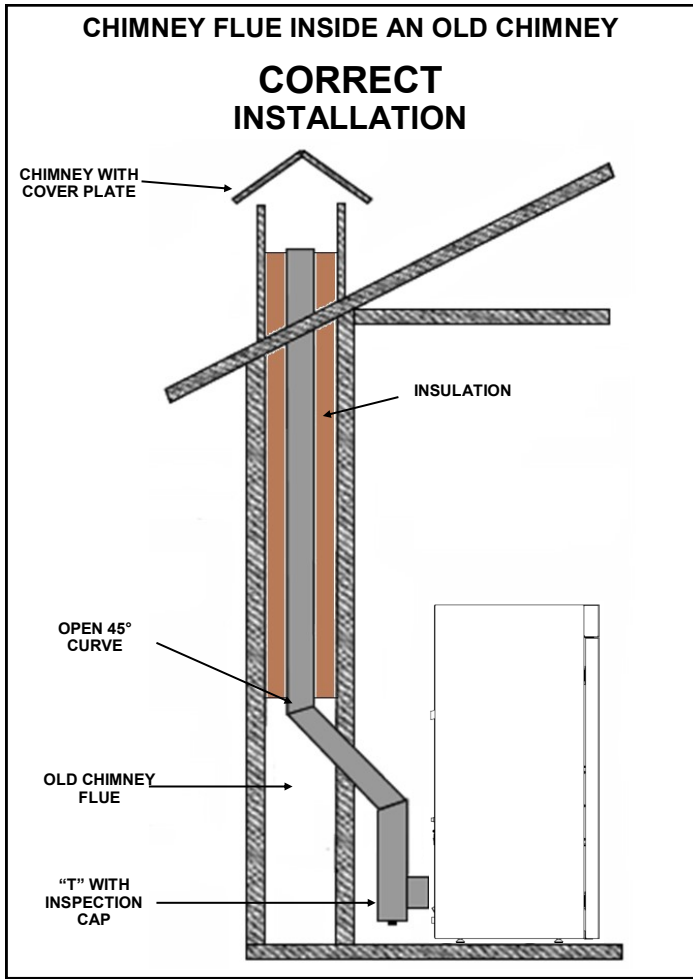

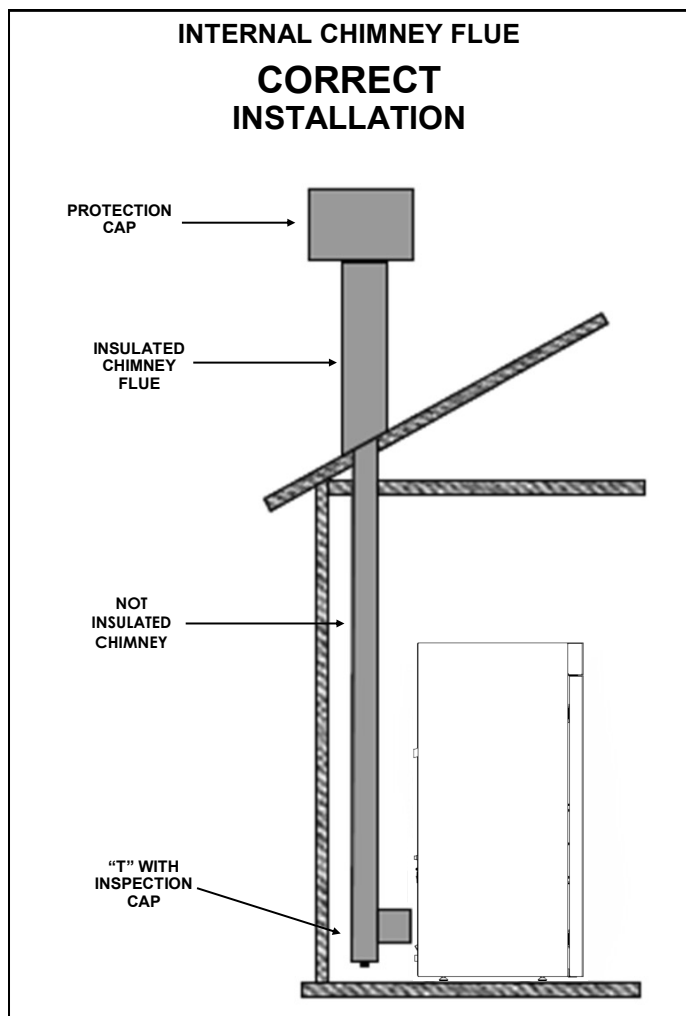
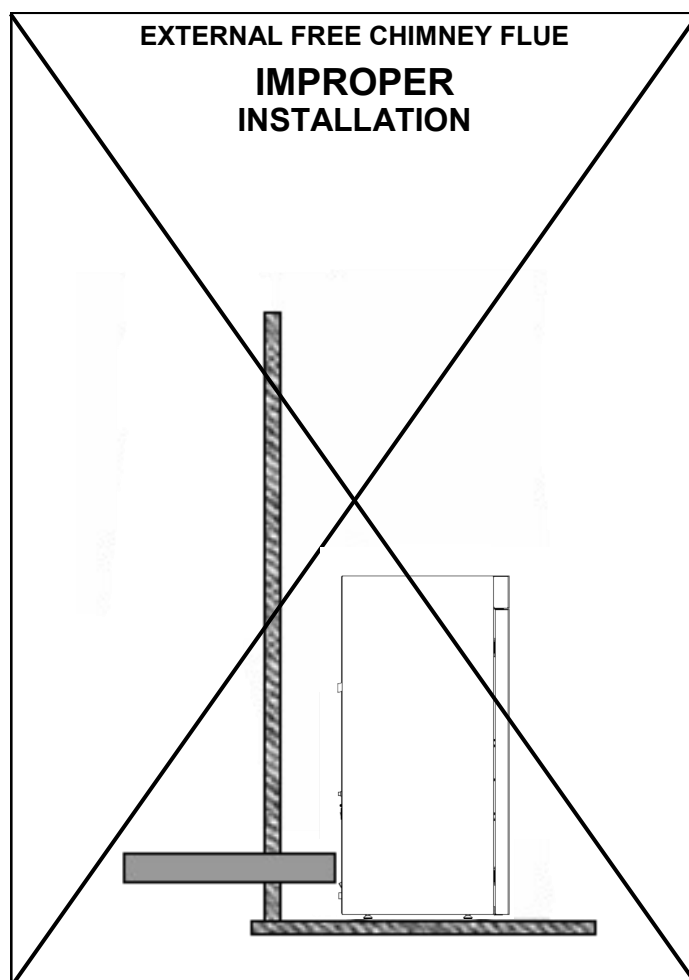
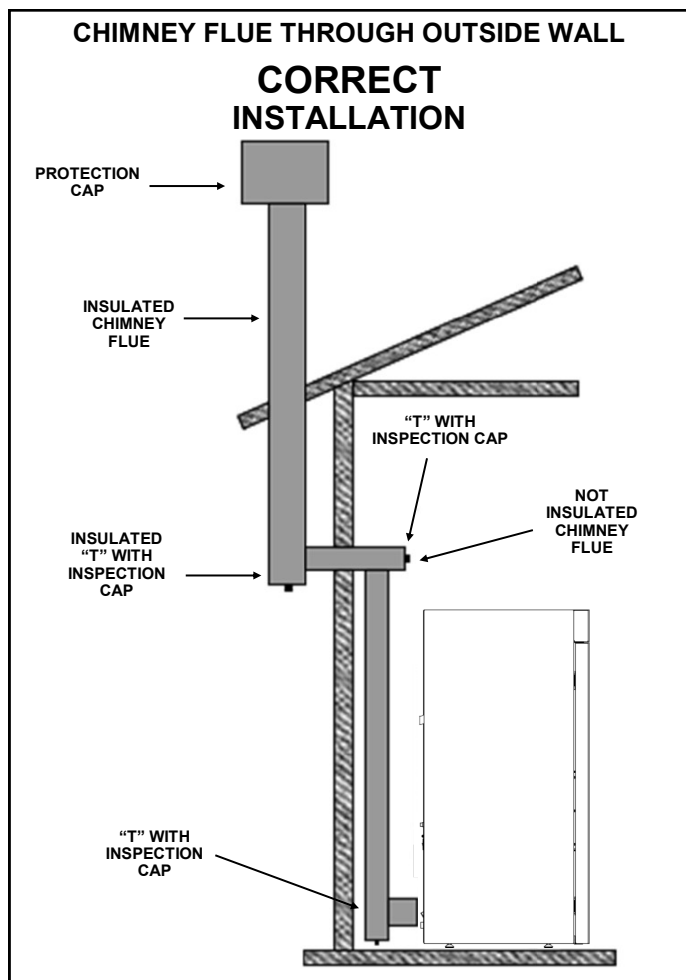

Warning:

The chimney must be constructed according to regulation standards.

For an external installation, use an insulated chimney flue that can be inspected on the curves. The outdoor section of the chimney flue must be insulated. Use only stainless steel tubes. Do not use synthetic materials or aluminium.

All sections of the fume exhaust must be accessible for inspections and internal cleaning.

In the internal section of the flue, provide one or more measuring points for emission control. The measuring points must be sealed.

The appliance works in depression at the smoke outlet and is equipped with a fan for the expulsion of fumes.

The minimum draft is indicated in the table of technical data.

Failure to comply with the above specifications will void the warranty.

Installation of the remote room thermostat

The boiler allow for the installation of a on/off remote thermostat. The connection for the remote thermostat is located on the back of the boiler straight under the power connector, it has a two pin connector coupling with two buttons, one black and one red. The connection to the thermostat assures the function that the boiler can go into Modulation.

Filling the system

Before installing the hydro stove it is recommended to carefully wash out all the tubes of the system in order to remove any debris that may affect the proper function of the appliance.

Once all plumbing connections have been completed, the system must be filled with water. Open all vents. Open the filling valve and check for any leaks. Close the tap and the vent valves. Start the pump several times to remove any eventual air pockets.

Warning: The exhaust of the safety valve must be connected to a drain so it can flush out incoming hot water.

Connecting to a system with zone valves

Leave at least one zone always open. We recommend installing an anti-condensation valve at 55 °C (mandatory in the case of direct connection to the system).

WARNING: the boiler must be installed on a properly sized system to dispose of the power generated by the appliance. For the sizing of the system it is recommended to rely on a thermo technician.

To dissipate excess heat, the boiler must be connected to at least two radiators. The system drain valve and the safety valve are on the back of the boiler, they must both be connected to a drain well according to the regulations in force.

Hot water production kit (optional)



On the boiler it is possible to install a kit on board of the appliance for the production of hot water. This optional feature provides unmatched comfort because everything is completely automatic and controlled by the control unit.

Note: The kit must be connected to the hydraulic system in accordance with its input and output indications, the maximum admissible pressure is 2 bars (this operation must be carried out by a qualified technician).

Long-term non-use conditions

If the hydro stove has not been used for a long period of time, it is recommended to contact a qualified technician to carry out the following operations:

- Apply adequate antifreeze according to the area where it is located
- Place the switch in the 1 position
- Close all the valves of the heating and domestic water system

Operating Conditions

The boiler has been designed to be used in ordinary environments, where there is no danger of fire or explosion. The disposal of combustion waste must be carried out in accordance with the applicable legal provisions.

When using the boiler, the settings of the safety devices or the fixed guards can not be changed. The control devices must be regulated by qualified technicians.

Maintenance of the boiler must be carried out by specialized companies in the maintenance of heating appliances, which will subject it to all the checks required by current regulations.



Use wood pellets with a diameter of 6mm, average length of 30mm, with humidity characteristics in compliance with the EN PLUS-UNI EN 14961-2 standard, class A1. Store the fuel in a cool, dry place away from heat sources.

Caution: The boiler modified or equipped with special applications must undergo a new conformity check. The incorrect connection of the boiler to the chimney and failure to comply with the provisions regarding the construction of the ventilation openings can cause serious dangerous situations.

Residual risks

Some parts, for example the smoke outlet, during operation may be very hot to the touch and cause burns. The electrical parts can cause serious damage, do not touch these parts without having disconnected the mains cable from the mains.

SAFETY DEVICES

Breakage of the exhaust fan: If for any reason the fan breaks, a safety measure intervenes and blocks the pellet flow (Er02), an alarm goes off and stops the stove's function.

Breakage of the auger motor: If the auger motor stops feeding pellet, the system still continues to function on minimum levels then an alarm goes off and the stove blocks (Er12, Er03).

Pump breakdown: If the circulator stops, the system goes into alarm and stops (Er01, Er04).

Ignition failed: The system has 1 ignition attempt, if it is not successful the boiler goes into a safe state then in BLOCK (Er12). Before each ignition, the brazier self cleans, in case of self-cleaning failure the system will go into error Er25.

Electrical protection: The system is protected with a 4 A fuse that is located on the back of the stove. To replace it, extract the tray next to the switch only after disconnecting the power cable from the power supply, replace the broken fuse and reinsert the tray, if the new fuse immediately breaks, contact a technician.

Exhaust fume safety: If there are any anomalies with the smoke expulsion from the system, an alarm will go off and the system will block (Er02).

Pellet safety: If the temperature inside the pellet tank exceeds the safety level, the system blocks (Er01). The reinstatement is automatic,

Water temperature safety: In case the water temperature in the boiler exceeds the safety level, the system goes into block (Er01). The reinstatement is manual and must be carried out by a qualified technician by pressing the reset button behind the boiler.

Water pressure safety: The pressure of the system is controlled by an electronic pressure transducer and must be in between 0.2 bar (200 mbar) and 2,8 bar (2800 mbar), se non sono rispettate le condizioni, il sistema va in blocco (Er09 o Er10), if these conditions are not complied with the system goes into block (Er09 or Er10). If the system goes over 3 bar, an automatic safety valve opens and releases the excessive pressure. To regulate the pressure within the function range, adjust the discharge valve behind the boiler or on the radiator.

Power failure: If there is a short power failure in the power supply, the system will go into BLOCK (Er15). If the lack of electricity is not brief, the boiler could release a small quantity of smoke in the room, if the air intake has not been correctly connected to the outside. **This is caused by the scarce draw of the chimney flue and does not represent any risk for one's safety.** When the power comes back, the system switches itself off.

Warning: In the case the chimney catches fire, call the fire brigade.

MINIMUM SAFETY DISTANCES

Keep fuels and flammable substances at an adequate distance from the stove. For minimum distances from flammable materials, one can refer to the products identification plate located on the back of the stove.

Caution: Some models could have minimum safety distances different from dimensions shown below, therefore it is strongly recommended checking always the identification plate located on the back of the stove to make sure the values of minimum safety distances.

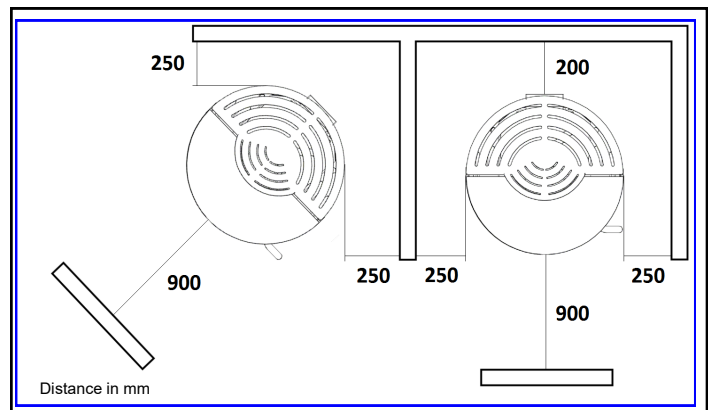

Note: The stove can be installed close to a not flammable material wall, as long as electronic devices and electrical connections will be accessible and there will be enough space for maintenance

Pellet loading

Fill the fuel tank with wooden pellets available on the market. Open the lid on the top and then pour the fuel in. It is recommended to close the pellet tank lid properly.

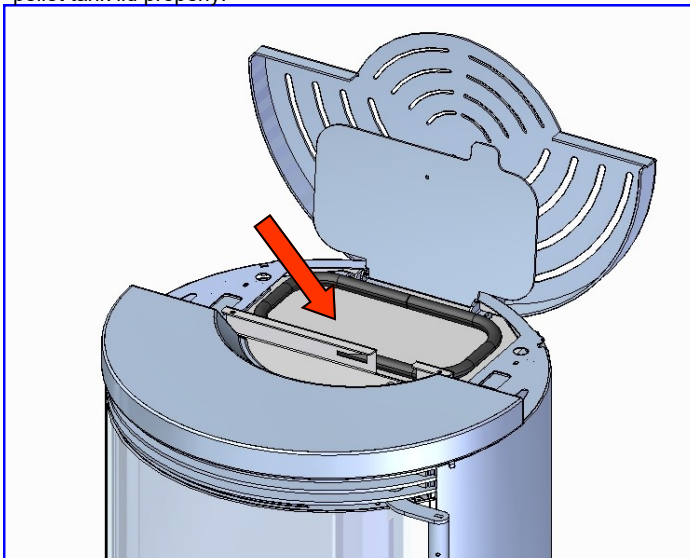

Use wood pellets with a diameter of 6mm, average length of 30mm, with humidity characteristics in compliance with the EN PLUS-UNI EN 14961-2 standard, class A1.

Warning: Before filling the tank, make sure that at the bottom there are no odd materials.

Ignition mode

Make sure that the boiler is connected to the electrical power and that the switch on the back is on position I

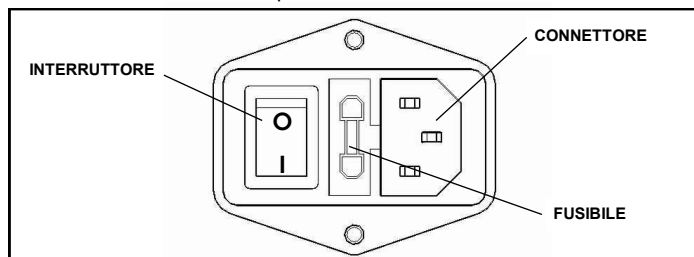

Fill the auger by using the **LOAD** function. During the ignition or even in run mode, the front door must always be kept closed.

Check **TOUCH DISPLAY** (pag. 9) and/or **RADIO DISPLAY** (pag.18) sections for ignition, room temperature and combustion power setting and for any further information.

OPERATING STATUS

Check Up

This phase starts as soon as the the On/Off button is pressed. During this phase the exhaust fan goes at maximum rpm, at the same time the system checks the probes and the safety devices.

Ignition

Once the Check Up phase is over, the system switches to the ignition phase. The system automatically cleans the brazier, at the end of which the cochlea loads a certain quantity of pellets and the ignition resistance turns on. The system waits for the combustion to start, after which it starts dosing small quantities of pellets to raise the temperature of the fumes.

Run Mode

After the ignition, the system goes into Run Mode. During this phase the heating fan is activated and the system operates on the set combustion power level.

Modulation

During the working phase in Run mode, the purpose of the boiler is to reach the boiler temperature set; when the set is

satisfied, the boiler goes into Modulation phase, phase in which the fuel consumption will be minimal.

Combustion power setting

It is possible to modify the combustion power level at any time, but the change is effective only in Run Mode. The power level ranges from 1 to 5. Increasing the power equals to a high pellet consumption.

Note: Turn off the stove in case of damage or malfunction.

COMBUSTION

The combustion is a chemical reaction in which a fuel (pellets) and an oxidiser (air) are combined, thanks to an ignition (resistance), in order to produce heat. They should be dosed in suitable proportions so that the combustion can take place. Following are some examples with a description and adjustment procedure to obtain an optimal combustion.

Automatic combustion regulation by FCS



The FCS (Fire Control System) is an automatic combustion control system that always keeps the product efficiency high.

The system self-adjusts the dosage of fuel (pellets) and combustion air based on the draft read by a flow meter sensor located inside the boiler..

The FCS system is therefore able to maintain an optimal flame even in the event of imperfect conditions (aspiration, flue draft, etc.), when these occur occasionally.

ATTENTION: the FCS system does not compensate for structural and continuous conditions of use and installation that are not up to standard, or in any case do not comply with the instructions given in the following manual regarding the quality of the pellets, flue or combustion air intake.

Therefore, it is advisable to check the quality of the flame by comparing it to the images in the examples above, since certain conditions of use and installation could in any case lead to machine malfunctions.

In any case, in the presence of **NOT OPTIMAL** combustion with the automatic combustion regulation system activated, it is recommended to contact an authorized **MORETTI DESIGN** technician.

Calibration (Item: Customizations - Service)

Note: On models where the FCS is installed, the automatic combustion correction range can be adjusted in the **FCS** item.

On models without the system, combustion can be adjusted manually using the **Auger Calibration** and **Fan Calibration** functions.



NON-OPTIMAL combustion, the flame is high and weak and of an orange color with a high quantity of unburnt pellets in the brazier.

- **Regulation on models with FCS:** First of all check the closure of the front door and tightness of the gaskets. Increase the **MCS Calibration** setting one point at a time (from 0 to +5) until the example 3 condition is achieved.
- **Manual regulation on models without FCS:** First of all check the closure of the front door and tightness of the gaskets. Then increase the **Fan Calibration** setting one point at a time (from 0 to +5). If it is not enough, reduce the **Auger Calibration** setting one point at a time (from 0 to -5) until the example 3 condition is achieved.



NON OPTIMAL combustion, the flame is too stretched and a large amount of burning pellets are blown out of the burner.

- **Regulation on models with FCS:** Reduce the **MCS Calibration** setting one point at a time (from 0 to +5) until the example 3 condition is achieved.
- **Manual regulation on models without FCS:** Reduce the **Fan Calibration** setting one point at a time (from 0 to -5). If it is not enough, increase the **Auger Calibration** setting one point at a time (from 0 to +5) until the example 3 condition is achieved.

Example 3



OPTIMAL combustion, the flame is vibrant of a yellow/white colour with a small amount of burning pellets inside the burner. It is not necessary to adjust any settings in the Calibration menu.

For all three of the examples, it is advised to evaluate on the spot all necessary adjustments.

FIRE PROTECTION

One must be extremely cautious in the vicinity of fire, flames, heat, electricity and other forms of energy, when using substances that can cause fire or explosions and also the relative equipment used to avoid them.

Owners, managers and users of buildings and facilities, must ensure the safety of people, animals and objects.

Owners, managers and users of buildings and facilities are responsible for the structures fire protection and heating systems. Buildings and installations must be kept in good conditions according to local standards and must always be ready for use.

People with surveillance duties must do what is necessary to instruct and train all users on how to apply all precautionary measures required.

Those who discover a fire must immediately sound the alarm and report the fire to the fire brigade and people at risk.

Safety distances between buildings and facilities must correspond to the minimum distances required by building regulations and, where necessary, must also comply with the minimum distances imposed by the fire protection descriptions.

Safety distances must be calculated in such a way as to prevent the propagation of fire between buildings and heating systems. All features such as size, location and use of the building must be taken into consideration.

In the case where the minimum safety distances imposed by building regulations do not correspond and cannot be modified, it is necessary to adopt additional measures to prevent the propagation of a fire.

All interior installations must be designed and constructed in conformity with local regulations and must ensure a limitation of damage in case of failure or damage.

Components, thermal resistance requirements, chemical and mechanical features of the installation, must all comply with local regulations and standards.

Attention!

If creaks emitted by the product should occur, they are not an indication of defects but are due to the normal thermal expansion of the materials.

- TOUCH DISPLAY (ONLY FOR TECNICA FOR HOME)
 HOMEPAGE DISPLAYS



To unlock the standby screen, press on the display for 5 seconds and the homepage will appear.

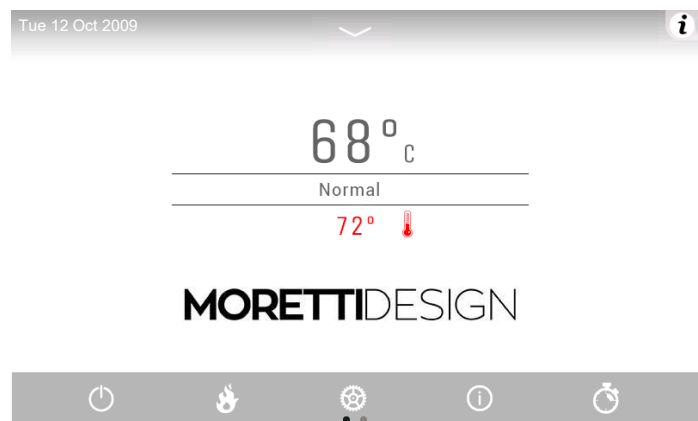

Description of key symbols

	Press to Confirm
	Press to Cancel
	Press to Edit
	Press to go back to the previous page
	Press to go back to the Homepage

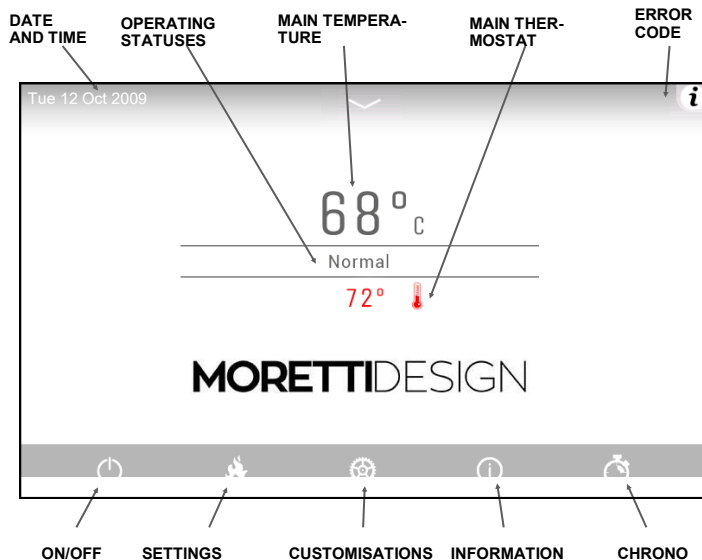

To view some of the main functions of the system, press on the screen with your finger and swipe vertically.

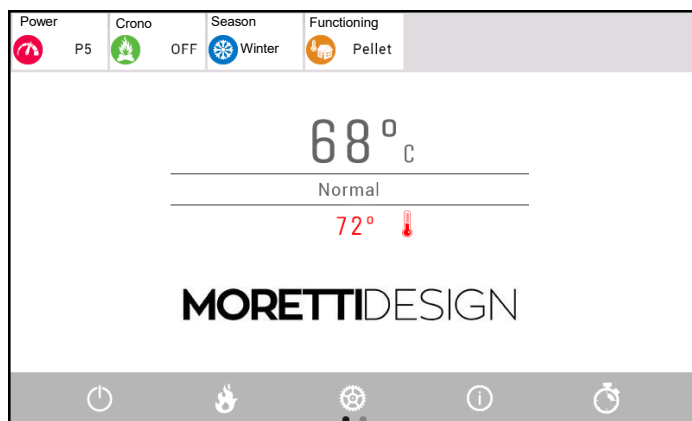

Operating Power (P5), Chrono Programming (OFF), Season Change (Winter), Operation (Pellet)



To view the second page of the main screen, press on the screen with your finger and swipe horizontally. This screen displays the individual active loads in real time.

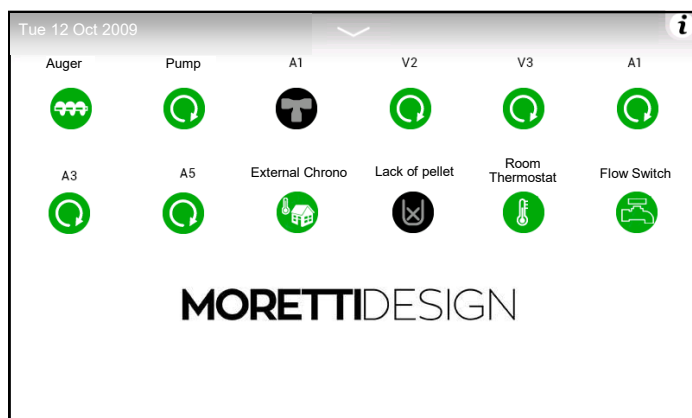

MAIN CONTROL DISPLAYS

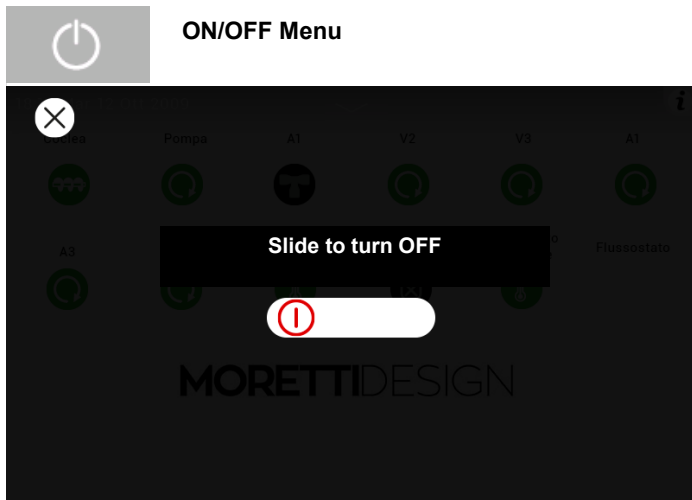

Press on the screen with your finger and swipe in the direction indicated to:

- Switch on the system
- Switch off the system
- Reset Alarms

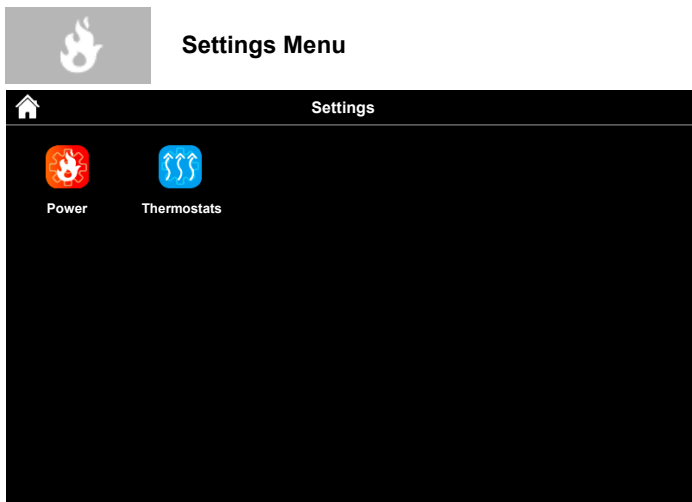

Power (pellet)

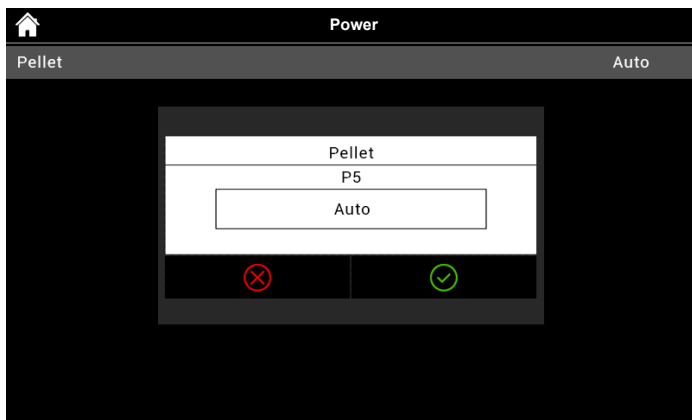

After selecting **Power**, it is possible to set the combustion power. There are 5 power levels (P1 - P5) and an AUTO level. By setting the AUTO level, the boiler adjusts the combustion power based on the value set on the boiler thermostat.

Thermostats

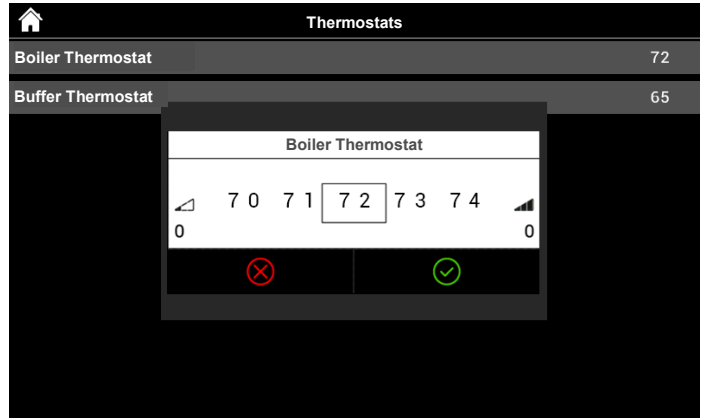

After selecting **Boiler Thermostat**, it is possible to set the water temperature that the boiler must reach.

It is possible to set a value between 53°C and 72°C.

- Storage Tank Thermostat

It can be viewed if the Storage Tank Probe/High Storage Tank Probe or Storage Tank Probe/High Storage Tank Probe and Low Storage Tank Probe and useful Hydraulic System Configuration are active.

- DHW Thermostat

It can be viewed if the DHW Probe and the useful Hydraulic System Configuration P26=2, 3, 10, 11 are active. The Maximum value can be programmed by setting Thermostat Th83.

- Delivery Thermostat

It can be viewed if the Return/Delivery Probe and the useful Hydraulic System configuration P26=9 are active. The Minimum and Maximum values of the thermostat are Th71 and Th72.

- Night Mode - SILENT AUTO CLEAN

Menu to set up and enable night mode switch on and switch off times. The menu is visible only if at least one of the following motors is enabled in night mode. Auger Motor, Cleaning Motor, Cleaning Motor 2 & Cleaning Motor 3

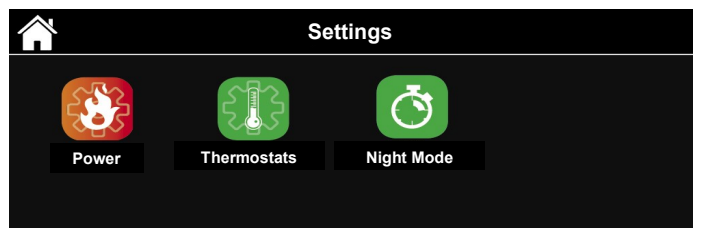

- Led - Mode

Allow activating, deactivating and setting up LED Auto Mode

- OFF -- Always off LED
- ON -- Always on LED
- Auto -- LED will light up when stove switches on and it will stay turned on for entire stove operating time. LED will turn off when stove switches off.

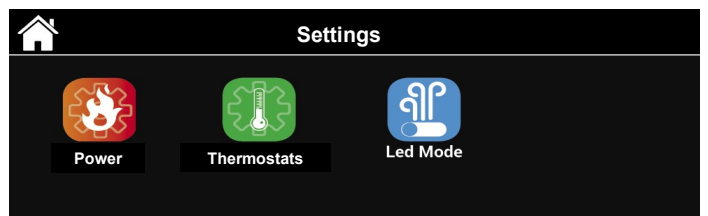

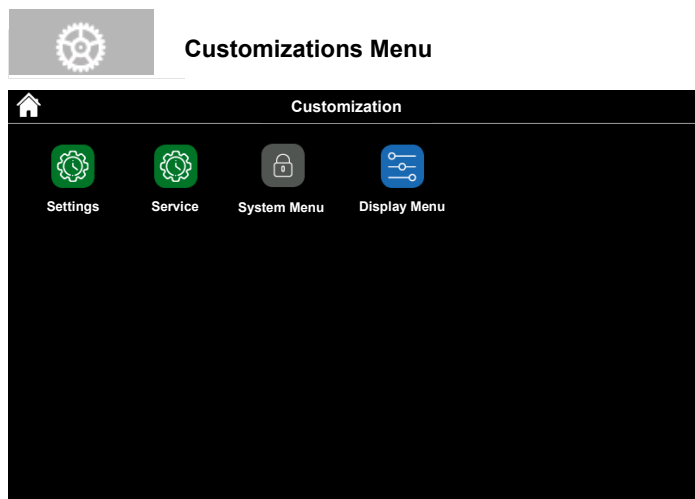

Settings



- Time and Date

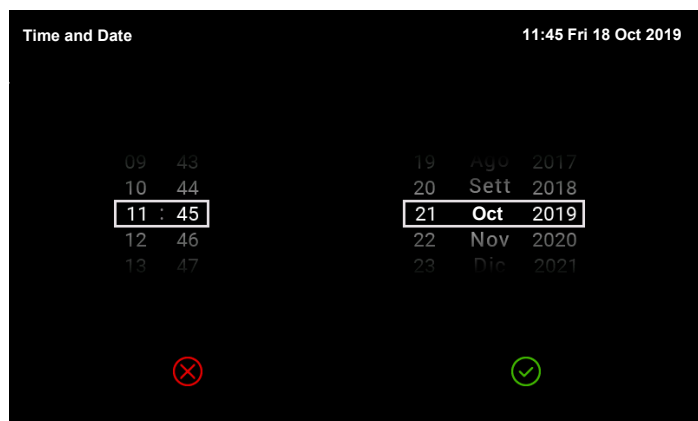

- Language

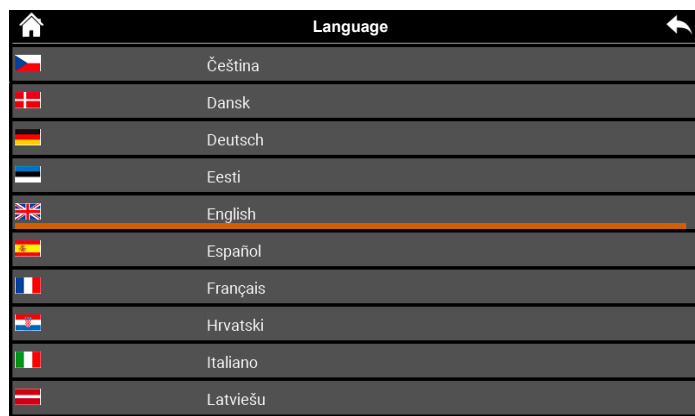

- Summer-Winter

Menu that allows you to select the Summer-Winter operating mode (if enabled).

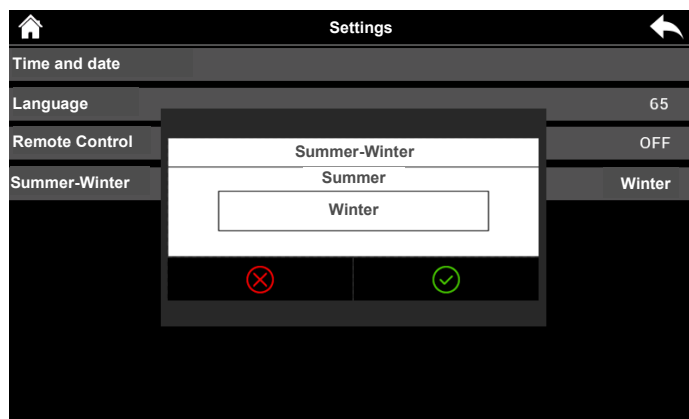

Service

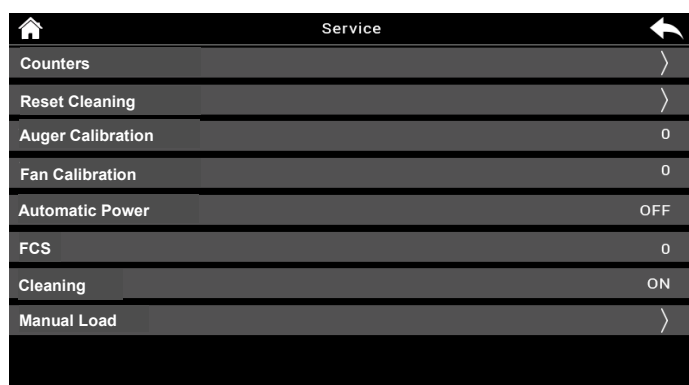

- Counters

Menu that displays: Number of Ignitions, Number of Failed Ignitions, Hours in Normal Condition.

- Reset Cleaning

To reset the Scheduled Routine Maintenance counter.

- Screw Feeder Calibration

If A24=0, the operation of the Combustion Fan can be adjusted as a percentage. There are 14 steps, 7 to increase and 7 to decrease; 0 corresponds to the default setting.

- Fan Calibration

If A24=0, the operation of the Combustion Fan can be adjusted as a percentage. There are 14 steps, 7 to increase and 7 to decrease; 0 corresponds to the default setting.

- FCS

If A24>0, the Flowmeter can be adjusted as a percentage. There are 14 steps, 7 to increase and 7 to decrease; 0 corresponds to the default setting.

- Cleaning

This menu allows you to activate or deactivate the automatic burn pot cleaning system; this process takes place during the ignition phase. It is recommended to keep it activated.

- Mixing Valve

It appears only if an output is configured as a Mixing Valve; this menu allows for the valve to be adjusted Automatically or Manually by forcing it to open or close.

- Load

The menu allows for the manual filling of the Screw Feeder. **The boiler must be OFF for this function to be performed.** If the Screw Feeder is manually activated, then the Smoke Fan is also activated, this is necessary so that the Pressure Switch can close the contact and the Screw Feeder can turn.

Display Menu

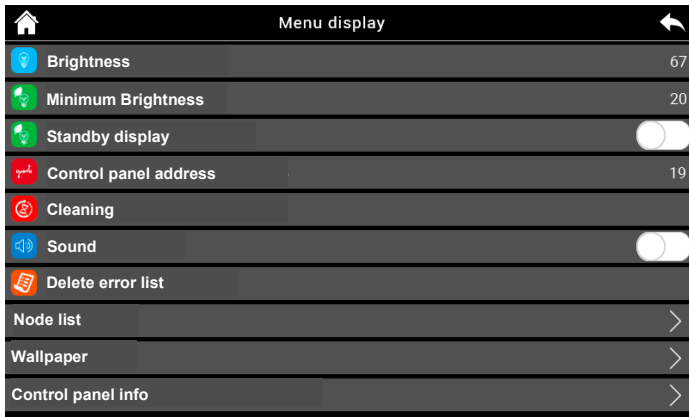

From this menu you can access the Touch Display settings.



Chrono Menu

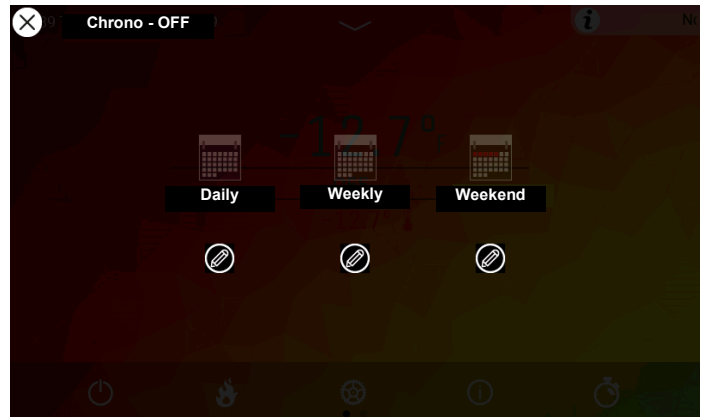

Menu used to program the automatic boiler switch on and switch off time slots. Any of the following can be selected: Daily, Weekly, Weekend.

To edit the chrono program, press the edit button.



Information Menu

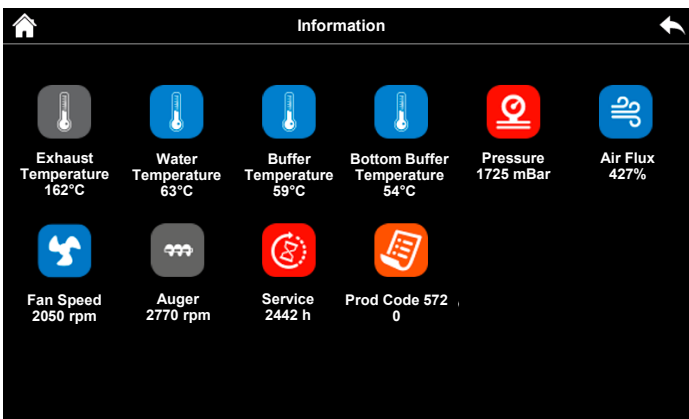

Menu to display the operating parameters of the system.

Daily

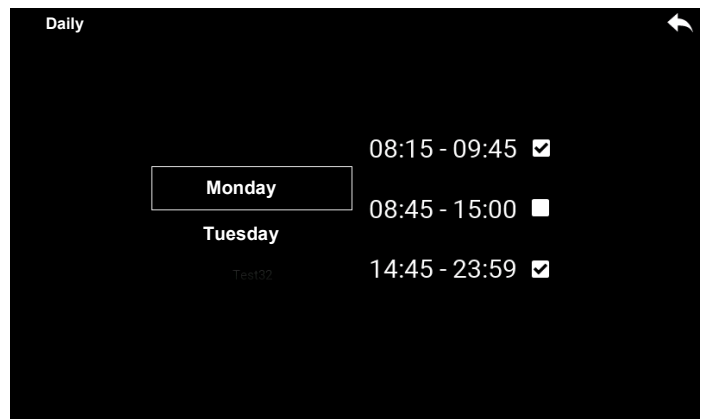

Select the day of the week you want to program, press on the on/off times and scroll up or down to change them. There are 3 time slots for each day.

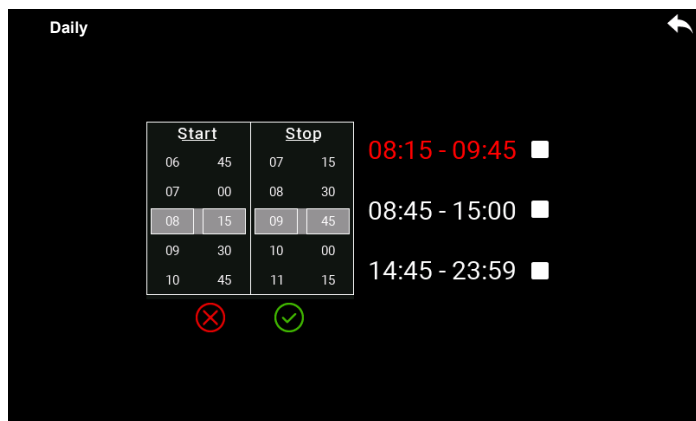

As shown in the figures, the switch on and switch off times have been programmed for the 3 available time slots:

1. 08:15 - 09:45
2. 08:45 - 15:00
3. 14:45 - 23:59

All three programs are between 00:00 and 24:00.

It is not possible to program a time slot such as: Switch on Tuesday at 17:00 - Switch off Wednesday at 04:30.

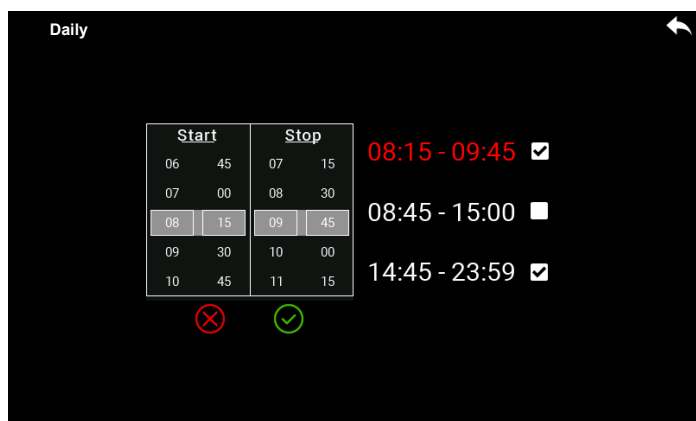

Once the time slot has been programmed, to enable it, a tick ✓ must appear in the appropriate box; simply press the box to the right of the switch off time.

Weekly

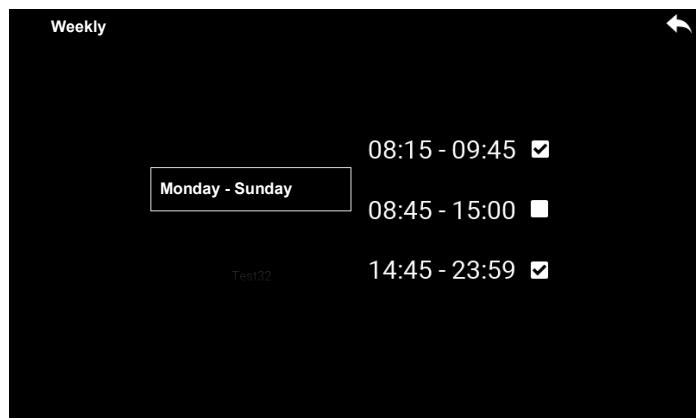

The switch on and switch off times are modified directly and there are 3 time slots available for the week.

Weekend

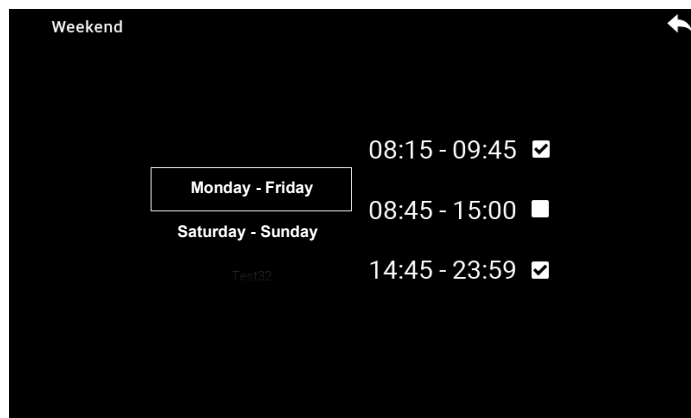

Select between the periods "Monday-Friday" and "Saturday-Sunday". There are 3 phases for "Monday-Friday" and 3 phases for "Saturday-Sunday".

The three types of programs are saved separately: if, for example, you want to adjust the Daily program, the other programs will not be modified.

BLOCKING AND NON-BLOCKING ERROR DISPLAYS

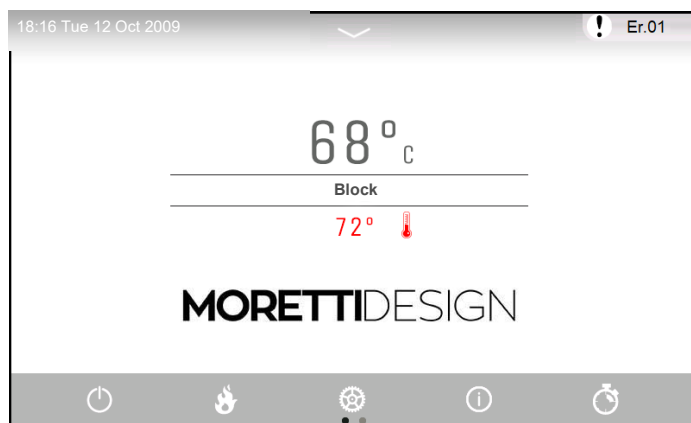

Any blocking or non-blocking errors are highlighted with a ! and the relative error code,

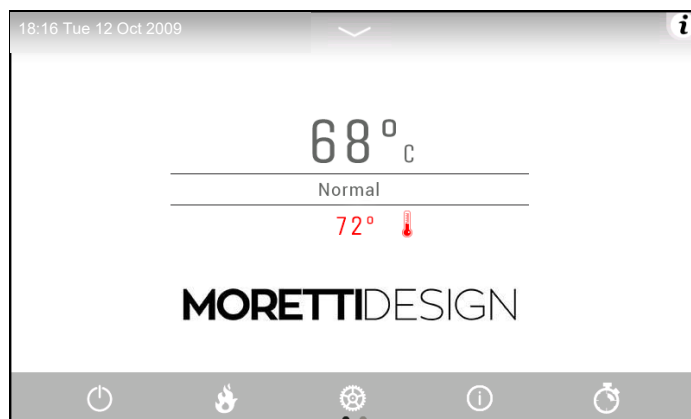

If there are no errors, the ! is replaced with the symbol i.

Press on the (i) with your finger to view the errors listed by date/time and their description.

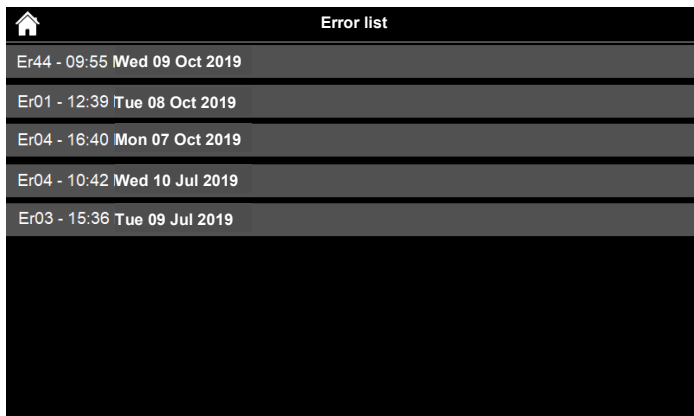

Example of Blocking Error

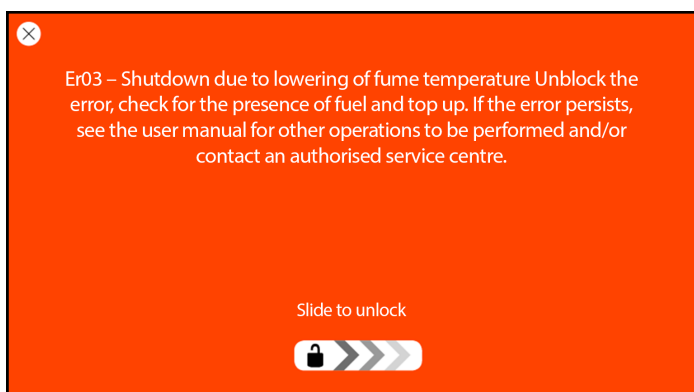

To unblock the error, press on the bottom bar on the screen and swipe horizontally. This operation can only be performed when the boiler is Off.

Example of Non-Blocking Error

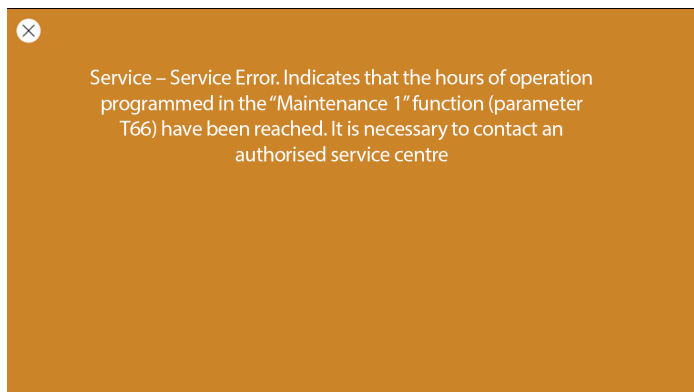

TOUCH DISPLAY (ONLY FOR TECNIKA TURBO GLASS)

DESCRIPTION OF CONTROLS

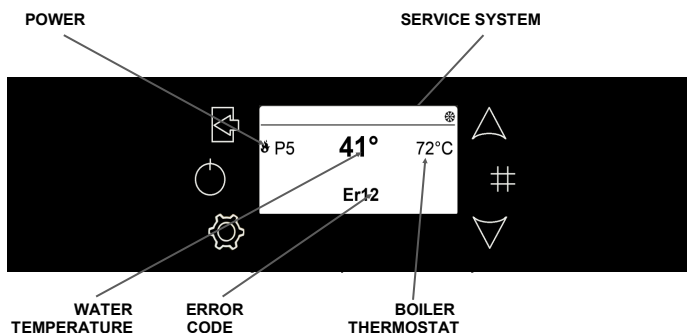
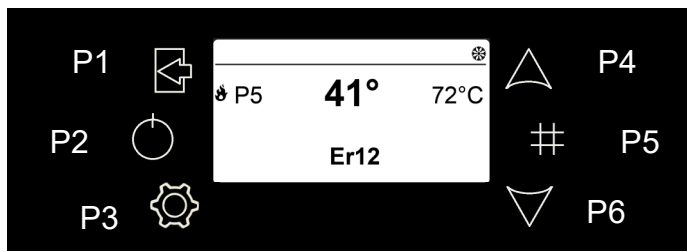

P1	Exit from a Menu or Submenu
P2	On and Off (press and hold for 3 seconds) / Reset Block (press and hold for 3 seconds)
P3	Enter a Menu or Submenu / Save data (To enter a submenu press and hold for 3 seconds)
P4	Increase power / Scroll through menu / Increase parameter values
P5	Operation parameters display menu / Chrono time slot enabling (keep pressed for 3 seconds)
P6	Decrease power / Scroll through Menu / Decrease parameter values

DESCRIPTION OF THE MENUS

The boiler is equipped with various functions, available in the individual programming menus. Some of these menus can be accessed by the user, others are password-protected and can only be accessed by the Technical Support Centre.

Displays

The Displays menu is used to view some important values.

- Simply press P5 (#) to enter, scroll through the pages and exit by pressing the same key. The value can be viewed next to the value name.

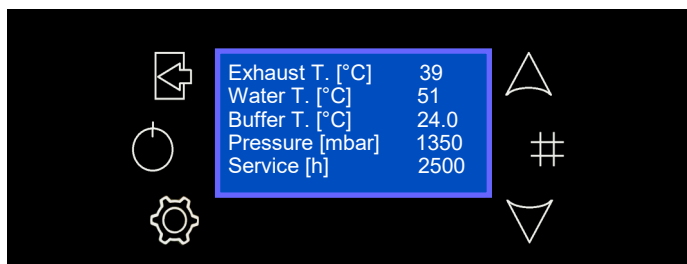

The menus are the following:

Simply press P3 to enter the following Menu

ORDER	MENU
1	Power
2	Thermostats
3	Chrono

Press and hold for 3 seconds P3 to enter the following Menu

ORDER	MENU
1	Settings
2	Service
3	Display
4	System Menu

Power

After selecting Power, it is possible to set the combustion power.

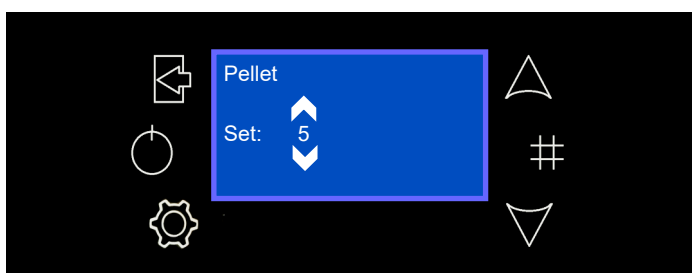

Thermostats

This item allows you to set the maximum water temperature in the boiler. Once this value has been reached, the system switches to Modulation mode.

- Press P3 to access the first page of the Menu, which consists of the User Menu.

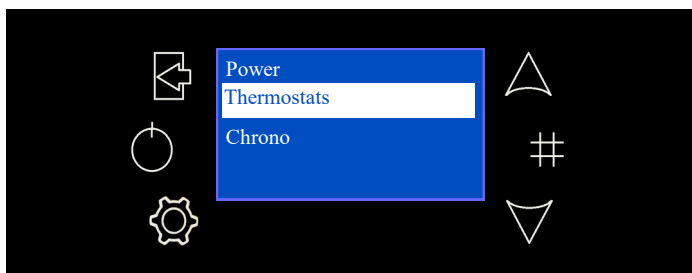

- Use the keys P4 and P6 to select Thermostats and press P3 to enter. Press P3 again to enter edit mode (the "Set" field flashes), use the keys P4 and P6 to increase or decrease the value and confirm the setting by pressing P3. Press P1 to exit the menu.



Storage Tank Thermostat (Only with configuration 2,3,4)

It activates only if one of the hydraulic configurations is selected. It allows you to change the temperature of the thermostat connected to a Storage Tank (see **HYDRAULIC SYSTEM MANAGEMENT** on page 17).

- Enter the menu by pressing P3, use the keys P4 and P6 to select Storage Tank Thermostat and enter by pressing P3. Press P3 to enter edit mode, select the desired mode using the keys P4 and P6 then save the setting by pressing P3 again. Press P1 to exit the menu.

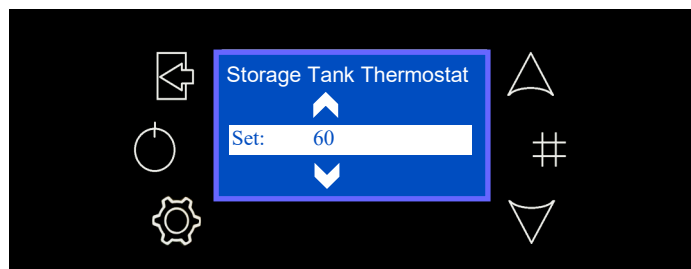

Chrono



This menu allows you to set the switch on and switch off time slots for the stove.

- Enter the Chrono menu and select between the two submenus: Modality or Program.

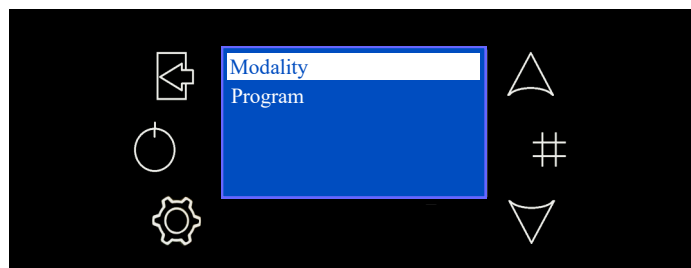

Modality

The selected item is highlighted.

- Enter edit mode by pressing P3, set "ON-OFF" by pressing P2, select the desired item by using the keys P4 and P6 and save the new setting by pressing P3. The system will exit the menu automatically.



If it is disabled, none of the programmed switch on times can be activated.

Program

Enter edit mode by pressing P3 and select the desired item by using the keys P4 and P6, enter by pressing P3.

Daily: Select a day of the week to be programmed (3 switch on/off time slots for each day).

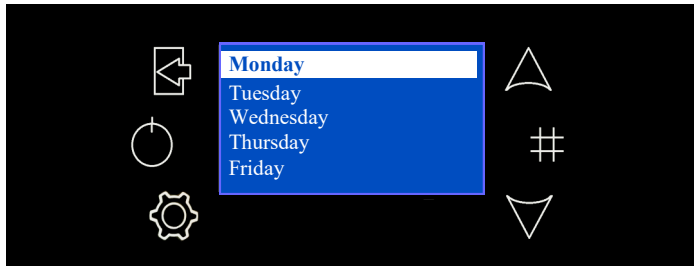

- When a day of the week is selected, the 3 switch on times are shown.

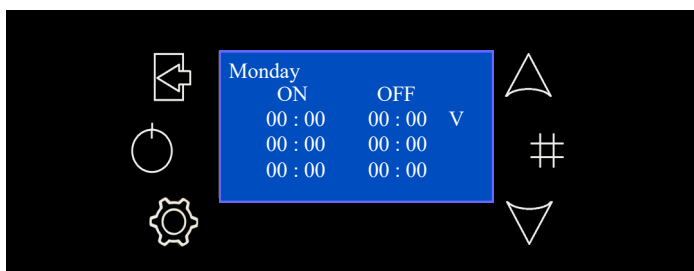

Weekly: The times are directly set (3 time slots for the entire week).

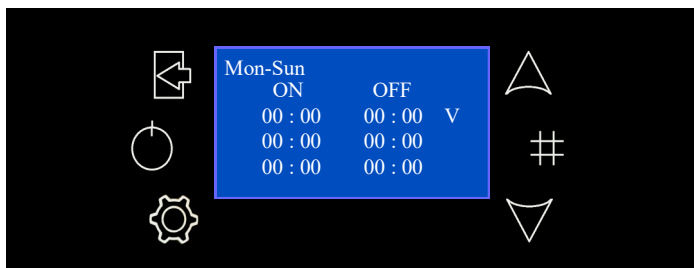

Week-end: It is possible to choose between two periods “Monday-Friday” and Saturday- Sunday” (3 time slots for the period “Monday-Friday” and 3 for the period “Saturday-Sunday”).

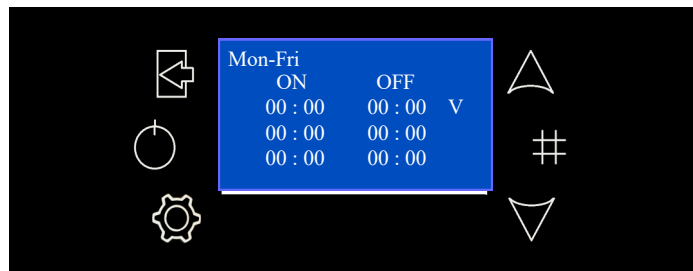
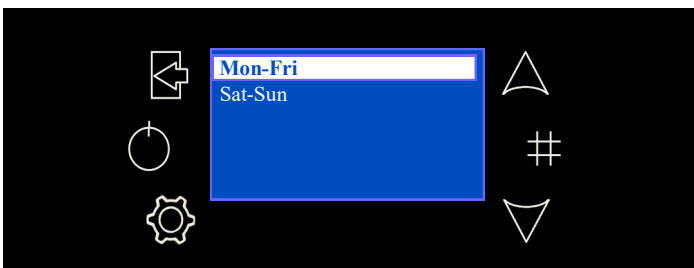

- After selecting the preferred program type, select the time to be programmed using the keys P4 or P6, enter edit mode by pressing P3 and change the values of the desired time slot using the keys P4 or P6. Save the changes by pressing P3 then press and hold P5 for at least 3 seconds to enable the time slot; a tick “V” will appear to the right of the time slot. Press P1 to exit.

To set a time slot that starts before midnight and ends after midnight, set the switch off time at 23:59 and the switch on time for the next day at 00:00.

The three types of programs are saved separately: if, for example, you want to adjust the Daily program, the other programs will not be modified.

Note: After programming one or more modes (Daily, Weekly, Week-end), in order to switch on the boiler using the Chrono function,

Settings

This item allows you to enter the following submenu

ORDER	MENU
1	Time and Date
2	Language
3	Remote Control
4	Summer-Winter

Date and Time

This menu allows you to set the current date and time.

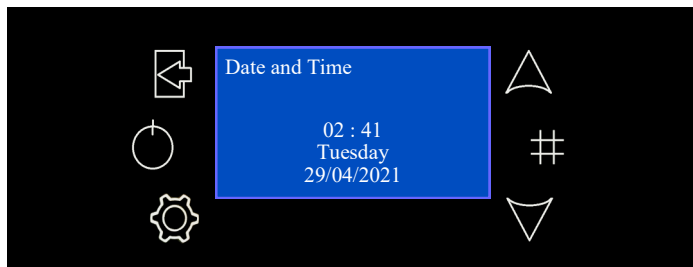

- Enter the menu by pressing P3, select Date and Time by pressing the keys P4 and P6, then enter by pressing P3. Press P3 to enter edit mode, select the desired mode using the keys P4 and P6 then save the setting by pressing P3 again. Press P1 to exit the menu.

Language

This menu allows you to change the language.

- Enter the menu by pressing P3, select Language using the keys P4 and P6, then enter by pressing P3. Press P3 to enter edit mode, select the desired mode using the keys P4 and P6 then save the setting by pressing P3 again. Press P1 to exit the menu.



Remote Control

Menu that allows you to enable or disable the Remote Control (not compatible with the boiler model).

Summer-Winter

It allows you to set the system in Summer mode (domestic hot water only, no heating) or Winter mode (domestic hot water and heating). It is necessary to change the setting only if hydraulic configurations 2 or 3 are used (see **HYDRAULIC SYSTEM MANAGEMENT**).

- Enter the menu by pressing P3, select Summer-Winter in the menu by pressing P4 and P6, then enter by pressing P3. Press P3 to enter edit mode, select the desired mode using the keys P4 and P6 then save the setting by pressing P3 again. Press P1 to exit the menu.

In Summer mode, the following symbol  appears on the display



Service

This item allows you to enter the following submenu

ORDER	MENU
1	Counters
2	Error list
3	Secondary Information
4	Auger Calibration
5	Fan Calibration
6	Automatic Power
7	FCS
8	Cleaning
9	Manual Load

Counters

Menu that displays: Hours in Normal Condition, Number of Ignitions, Number of Failed Ignitions.

Attention: to be used only by an authorized **MORETTI DESIGN** technician

Error list

This item allows you to read the system error list

Attention: to be used only by an authorized **MORETTI DESIGN** technician

Secondary Information

This item allows you to read the secondary information related to the system

Attention: to be used only by an authorized **MORETTI DESIGN** technician

Auger Calibration

This item allows you to adjust auger rotation speed

Attention: to be used only by an authorized **MORETTI DESIGN** technician

Fan Calibration

This item allows you to adjust exhaust fan rotation speed

Attention: to be used only by an authorized **MORETTI DESIGN** technician

Automatic power

This item allows you to switch on and to switch off automatic combustion power

Attention: to be used only by an authorized **MORETTI DESIGN** technician

FCS

This item allows you to adjust the combustion parameters

Attention: to be used only by an authorized **MORETTI DESIGN** technician

Cleaning



This menu activates (ON) or deactivates (OFF) the automatic burn pot cleaning system. This process takes place at the beginning of the ignition phase.

Note: It is recommended to always keep it active (ON).

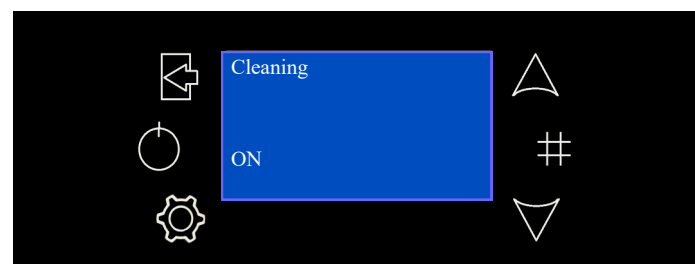

Manual Load

This item allows for the manual filling of the Screw Feeder.

Note: This control works only with the boiler off and not blocked.

- Enter the user menu by pressing P3, select Load using the keys P4 and P6, then enter by pressing P3. Press P3 to enter edit mode, select the desired mode using the keys P4 and P6 then save the setting by pressing P3 again. Press P1 to exit the menu.

Note: Once the loading procedure is complete, empty the burn pot before the ignition phase.

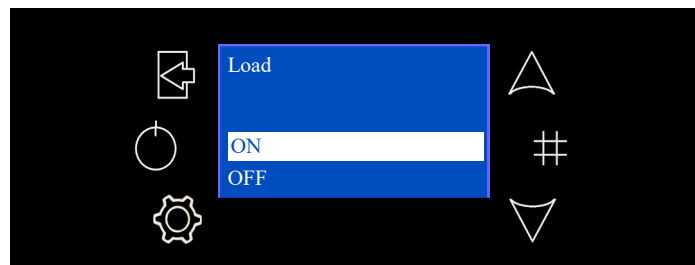

Display

This menu allows you to adjust the contrast, minimum brightness, to switch on and to switch off the screen saver and the acoustic alarm

- Enter the menu by pressing P3, select display menu using the keys P4 and P6, then enter by pressing P3. Press P3 to enter edit mode, select the desired mode using the keys P4 and P6 then save the setting by pressing P3 again. Press P1 to exit the menu.

System Menu

Menu to access the Secret Menu reserved for the authorised **MORETTI DESIGN** Technician. Access to the page is **PASSWORD** protected.



- DISPLAY RADIO (AQUA) Cod. PSYSI04000005

Introduction

The radio display (black) is a wireless device for the stove it is associated to and it can be used to manage and monitor the system's functions in real time.

Its main features are:

- Battery-powered remote control of the system.
- Room Thermostat.
- Operating parameters management system.

Warnings: the system uses the 868.3MHz radio band. The range of the device can be significantly reduced in a noisy environment: other appliances such as wireless headphones, videos or other devices may affect the performance of the system. Check if there are any appliances in the surrounding area and turn them off or limit their use. In the case of interaction of multiple radio displays with several stoves, it is necessary to associate each radio display to a specific stove (see "Code change" section).

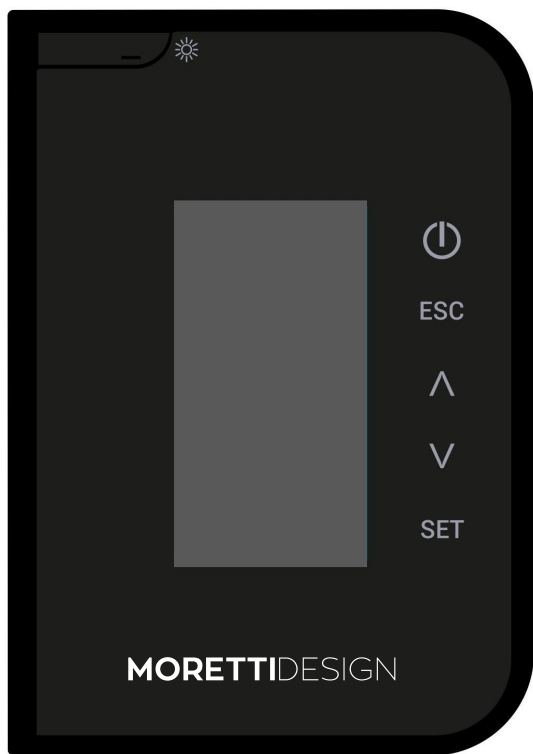





Descrizione Tasti

Tasto	Funzione	Descrizione
☀	Sleeping Mode	By pressing the button when the main screen is displayed, the radio display will continue to function but it will enter "sleeping mode" thus decreasing battery usage. Press the key to turn the radio display back on.
	Standby Mode	Press the key for 3 seconds from the main screen to turn off the radio display completely, thus decreasing battery usage. This feature is to be used during periods of inactivity of the radio display. If the function is active, the system uses the room probe connected to the stove. To turn on the radio display again, press the key and press twice 
⏻	On/Off	Switch the stove On/Off by pressing the button for 3 seconds
	Unblock	Unblocks the system by pressing the button for 3 seconds
ESC	Esc	Exit from menu
^	Power setting	Combustion power setting
	Scroll through Menus and Sub-menus	Scroll through menus and submenus, increase and decrease values, room temperature
SET	Set	Enter submenus, edit values, save data

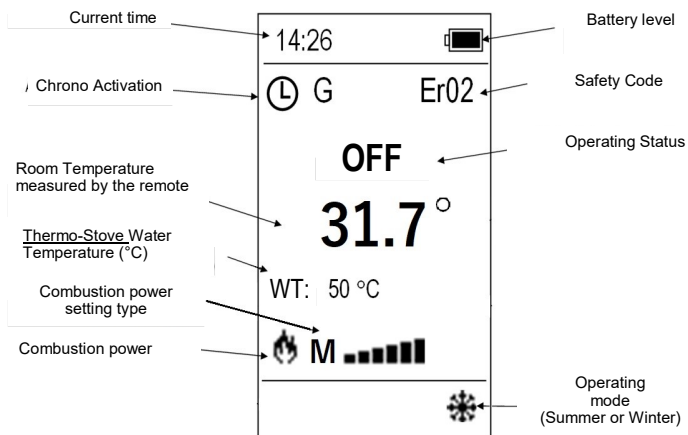

The display will turn on when the key is pressed and the main screen appears.

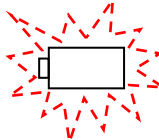

	Batteries full		Batteries empty; replace batteries as soon as possible. The Image flashes.
	Battery charge level at 2/3		
	Battery charge level at 1/3		

OPERATING STATUSES

Check Up

This phase begins as soon as the On/Off button is pressed. During this phase, the system cleans the burn pot by operating the smoke fan at maximum speed and simultaneously checks the probes and safety devices.

Ignition

After the Check Up phase has been completed, the system starts the Ignition phase. The Screw Feeder loads a quantity of pellets into the burn pot and the ignition resistance is activated. The system waits until the combustion begins, then it starts to load small amounts of pellets in order to raise the temperature of the fumes.



Power (Pellet)

The power can be changed directly from the remote control following this procedure:

- Press the \wedge key on the remote control to enter the power menu
- Select the desired power using the appropriate keys \vee \wedge
- Press the SET key once the desired power has been selected.

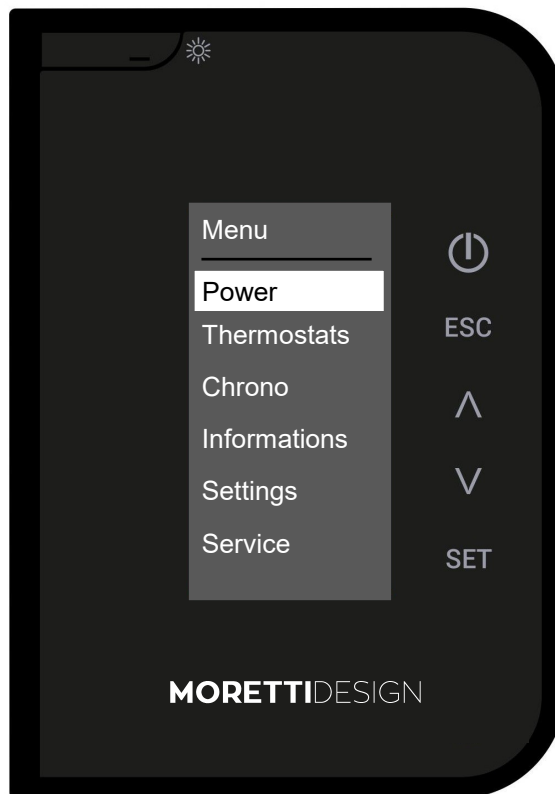

Normal Stabilisation

After the stabilisation phase, the system switches to Normal mode. During this phase the heating fan is activated automatically after a short period; then its speed should be set according to the combustion power of the thermo-stove. During Normal mode, the words CLEANING ON may appear for a few seconds; during this time the thermo-stove automatically cleans the burn pot, before returning to Normal mode.

Modulation

During operation in Normal mode, the aim of the stove is to reach the set room temperature; when this goal has been achieved, the system switches to Modulation mode where the fuel consumption is minimal and the room fan will run at the lowest power setting.

Combustion power setting

It is possible to change the combustion power level at any time, but the change is effective only during Normal mode. The power level ranges from 1 to 5. Increasing the power level increases the pellet consumption and hot air fan speed. In addition to the 5 power levels, there is also Auto level where the combustion power level is managed automatically by the stove.

Note: Turn off the stove in case of failure or malfunction.

THE MENUS

To enter the user menu of the radio display, press the SET key. A list of submenus will appear. When a new value is saved, it is associated to a certain stove.

Thermostat

Menu to change the radio thermostat value

- To scroll through the \vee \wedge menu, use the SET key, to scroll through the items use the keys

To confirm press SET. To exit press ESC.

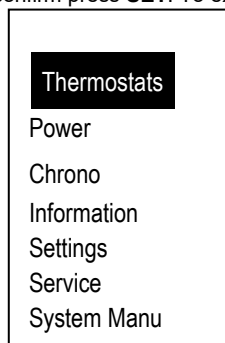

- Boiler Thermostat: It allows you to change the value of the boiler thermostat inside the thermo-stove. .
- Storage Tank T: It allows you to change the value of the storage tank thermostat. It appears only if configurations 2, 3 or 4 are used (see HYDRAULIC SYSTEM MANAGEMENT).

Chrono

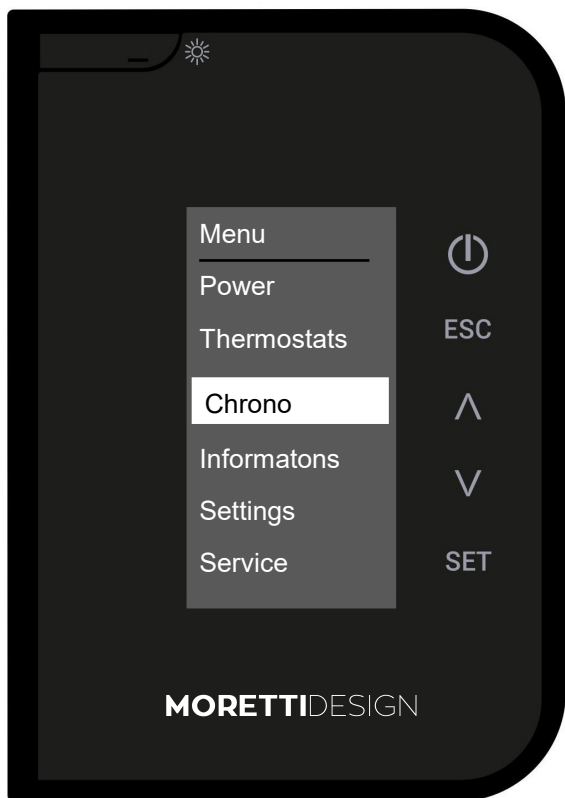

- This menu is used to set the stove switch on and switch off time slots.

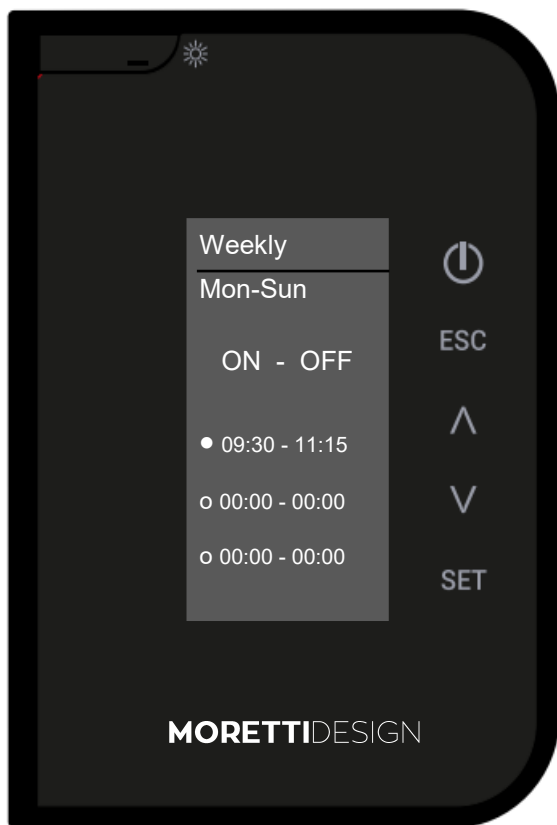

- To scroll through the items of the menu, use the **SET** key; to change the data, use the keys ∇/\wedge . Exit by pressing **ESC**.

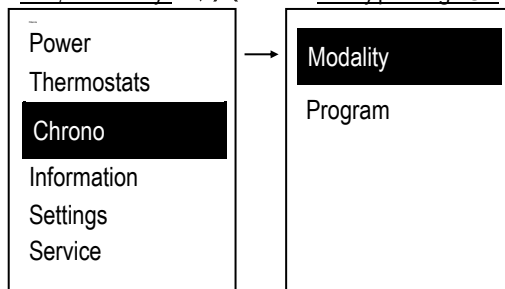

Modality: To turn on the stove via Chrono, select the mode after programming the switch on and switch off times. To enable the mode, press ⏻

- To scroll through the items of the menu, use the keys ∇/\wedge to confirm the data press **SET**. To exit press **ESC**.

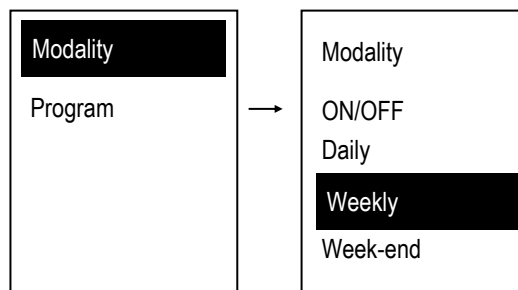

Programming: Select the type of program to set (after programming, to switch the system on and off via chrono, it is necessary to select the desired mode from the Mode submenu to enable it):

- To scroll through the items of the menu, use the keys \wedge/∇ . To confirm the data press **SET**. To exit press **ESC**.

Daily

Select the day of the week you want to program and set the switch on and switch off times. There are 3 time slots for each day.

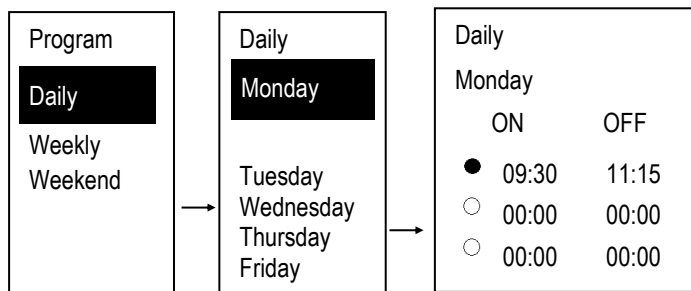

Weekly

The switch on and switch off times are modified directly and there are 3 time slots available for the week.

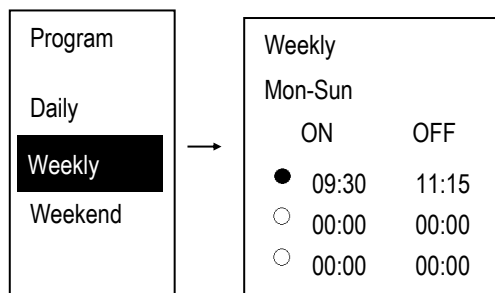

Weekend

Select between the periods "Monday-Friday" and "Saturday-Sunday". There are 3 phases for "Monday-Friday" and 3 phases for "Saturday-Sunday".

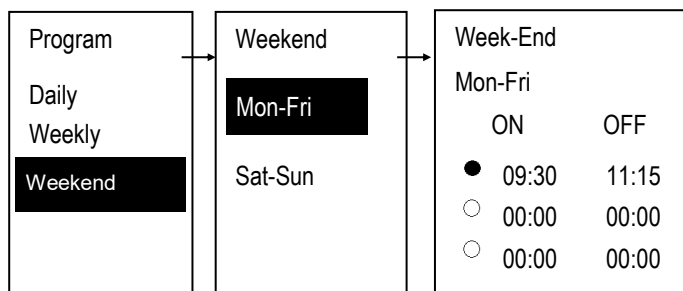

Enabling a time slot

Once the desired program has been selected:

- Select the time to be programmed and enter edit mode (the selected time will flash) and press **SET** to confirm.
- Change the times using the keys ∇/\wedge and save by pressing **SET**.
- When the time slot is enabled, ● appears; when it is disabled, ○ appears. Enable and disable by pressing ⏻
- Press **ESC** to exit.

Programming over Midnight

Set the OFF time to 23:59 for a time slot of one day of the week. Set the ON time to 00:00 for a time slot on the next day.

The three types of programs are saved separately: if, for example, you want to adjust the Daily program, the other programs will not be modified.

Informations

This menu allows you to view some of the system operating parameters.

- To scroll through the items of the menu, use **SET**, then use the keys ∇/\wedge to move between the various functions. To exit press **ESC**.

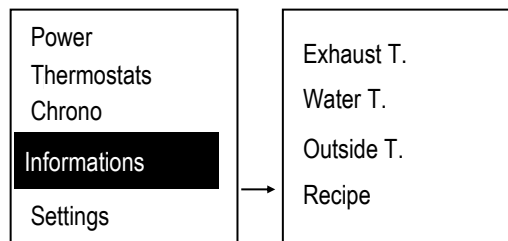

Led - Mode (only for Vision Aqua, Dolby Aqua, Slot Vision)

This menu allows LED switch on, switch off and enabling LED "Auto" function

- OFF -- LED always off
- ON -- LED always on
- Auto -- LED will light up when stove switches on and it will stay turned on for entire stove operating time. LED will turn off when stove switches off.

Radio Thermostat: This menu allows you to set the operation of the radio room thermostat.

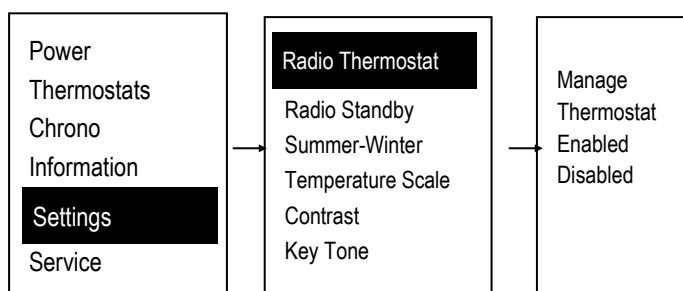

Radio Standby: Menu to switch off the radio display completely.

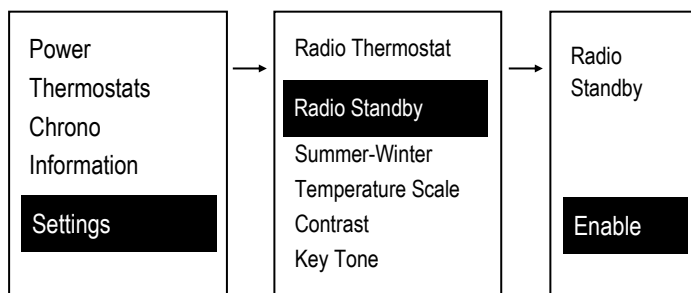

To switch on the radio display again:

- To reactivate the remote control, press ☼ first and then press ⏻ twice

Night Mode - Silent auto clean

This menu allows you to set and enable night mode switch on and switch off times.

The menu is available only if at least one of the following motor is enabled in night mode.

Auger Motor, Cleaning Motor, Cleaning Motor 2 & Cleaning Motor 3

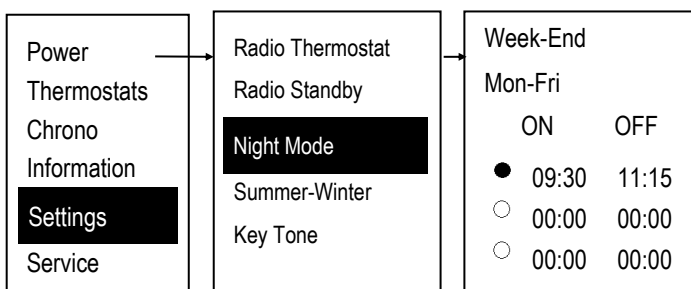

Summer - Winter

This menu allows you to select the Summer or Winter operating mode only if configurations **0, 2, 4 and 6** are used (see **HYDRAULIC SYSTEM MANAGEMENT**).

Temperature Scale

This menu allows you to select the desired temperature scale. It is factory preset to Celsius.

Contrast

This menu allows you to adjust the display contrast.

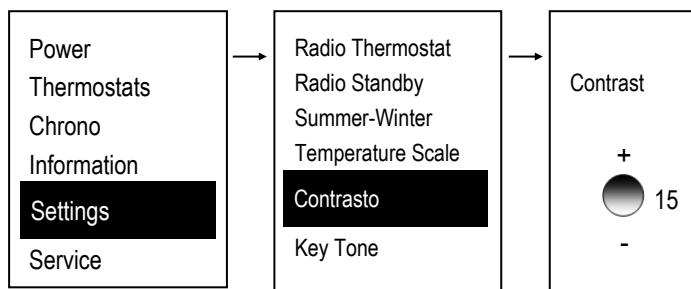

Key Tone: This menu allows you to turn off and turn on the sound of the keys when pressed.

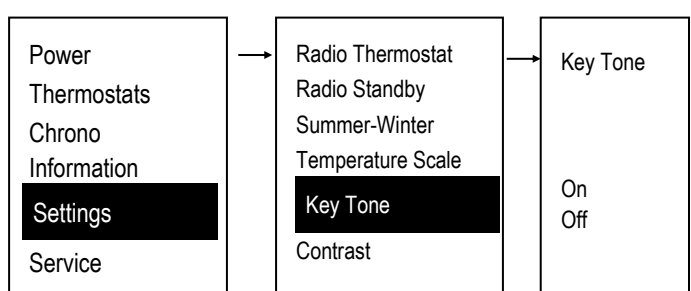

Date and Time

This menu allows you to set the current date and time.

- To scroll through the items of the menu, use the ∇/\wedge keys, to confirm the data press **SET**. To exit press **ESC**.

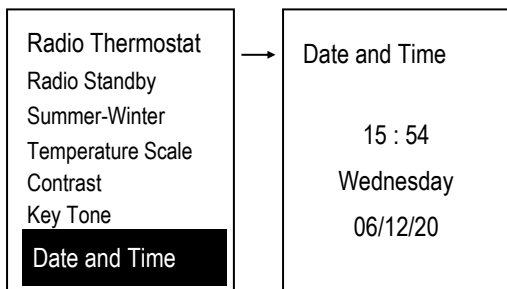

- Select hours, minutes and date using ∇/\wedge
- Enter edit mode (the cursor flashes) by pressing **SET**.
- Change the selected value using the keys ∇/\wedge and save the setting by pressing **SET**.
- Press **ESC** to exit.

Language

Menu that allows you to change the language settings.

- To scroll through the items of the menu, use the keys ∇/\wedge to confirm the data press **SET**. To exit press **ESC**.

Service

- To scroll through the items of the menu, use the keys ∇/\wedge per confermare ogni dato utilizzare **SET**. To exit press **ESC**.

Counters:

This allows you to view the following device data:

- Hours of Operation**
- Ignitions**
- Failed Ignitions**

Error list

This menu allows you to view the list of the latest errors reported by the stove.

WiKey Thermostat

This menu allows you to change the WiKey thermostat value

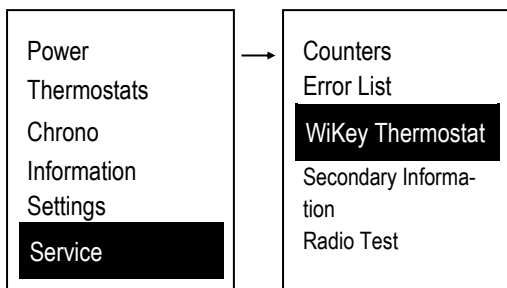

- To scroll through the items of the menu, use the keys ∇/\wedge to confirm the data press **SET**. To exit press **ESC**.

Secondary Information

This menu allows you to view some of the system ∇/\wedge operating parameters.

- To scroll through the menu, use the keys ∇/\wedge to confirm the data press **SET**. To exit press **ESC**.

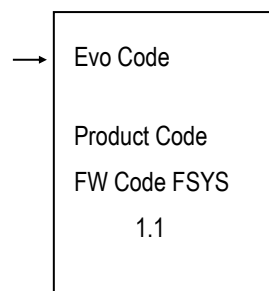
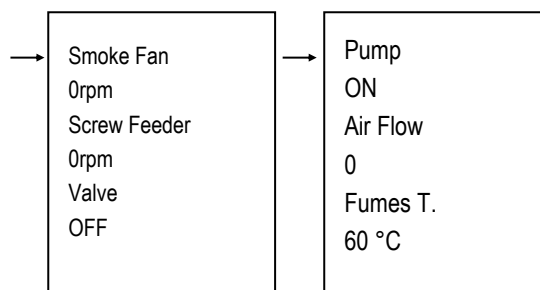
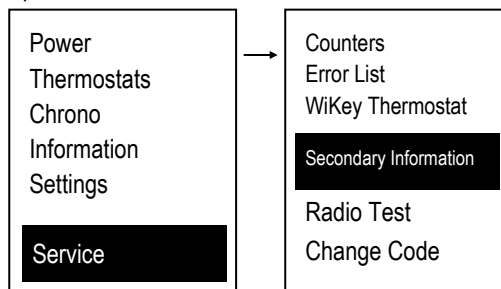

Radio Test

This menu allows you to check if there is a proper transmission between the radio display and the stove. The test also checks if there are other transmitting devices operating in the same environment.

When the function is activated, the radio display transmits (**Tx**) continuously and counts all the signals received (**Rx**) or not received (**Er**) by the stove.

In the following example:

Tx = 624 (Transmissions emitted by the radio display)

Rx = 611 (Signals received by the stove)

Er = 11 (Signals not received by the stove)

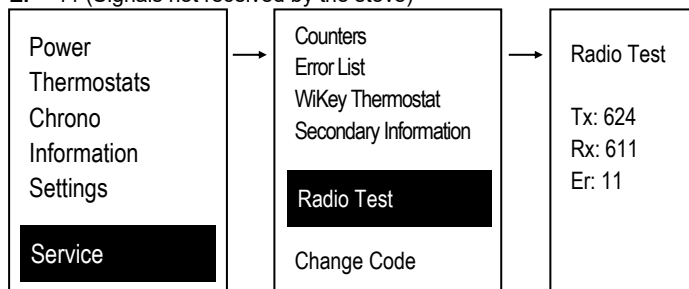

This example shows an excellent transmission quality between the radio display and the stove.

Change Code: This function allows you to associate the radio display to a specific stove so that only one remote can operate it (in this way, several transmitting systems can be used in the same room). To change the code and associate the radio display to a specific stove:

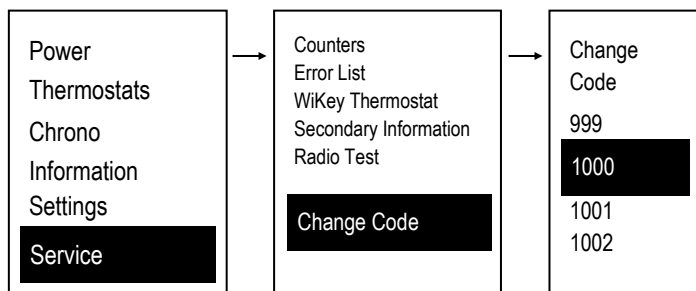

- Select a new code in Change Code:
- Turn off the main switch of the stove to prepare it for the code changing operation.
- Press and hold **SET** on the radio display and, at the same time, turn on the main switch on the stove and check the outcome of the operation.

If the words **Transfer Failed** appear, repeat the procedure and select a different code.

Reset Cleaning: Menu to reset the burn pot cleaning system

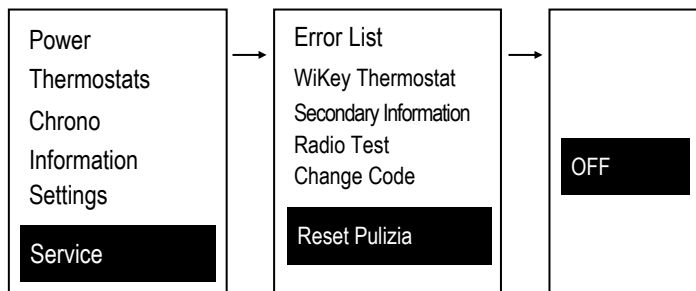

Screw Feeder Calibration

Menu to change the Screw Feeder operating time. There are 14 steps, 7 to increase and 7 to decrease; 0 corresponds to the default setting.

Attention: to be used only by an authorized **MORETTI DESIGN** technician

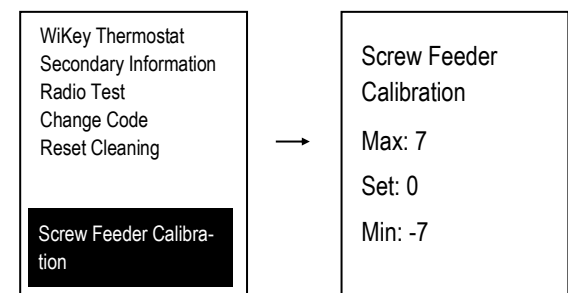

Fan Calibration:

Menu to change the Combustion Air Fan speed. There are 14 steps, 7 to increase and 7 to decrease; 0 corresponds to the default setting.

Attention: to be used only by an authorized **MORETTI DESIGN** technician

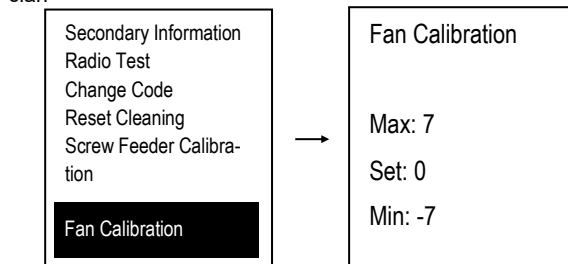

Automatic Power:

Menu to set power management in automatic mode.

Attention: to be used only by an authorized **MORETTI DESIGN** technician

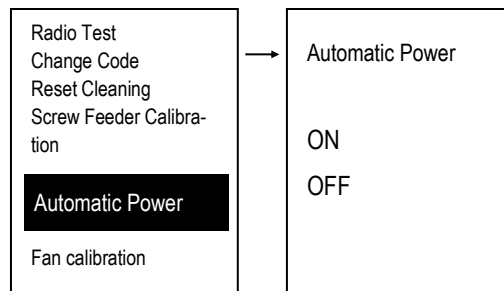

Load

This menu allows for the manual filling of the Screw Feeder. **The stove must be OFF for this function to be activated.** If the Screw Feeder is manually activated, then the Smoke Fan is also activated, this is necessary so that the Pressure Switch can close the contact and the Screw Feeder can turn.

- To scroll through the items of the menu, use the keys ∇ \blacktriangle to confirm the data press **SET**. To exit press **ESC**.

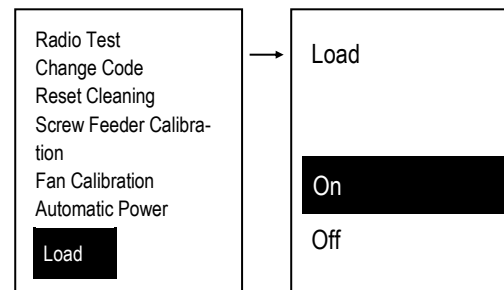

Loading Test

The Menu allows for the manual filling of the Screw Feeder and allows you to check its correct operation.

- To scroll through the items of the menu, use the keys ∇ \blacktriangle to confirm the data press **SET**. To exit press **ESC**.

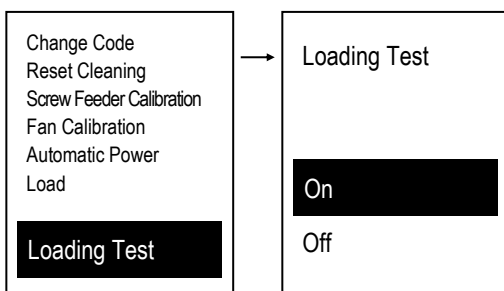

System Menu

Menu to access the Secret Menu reserved for the authorised Technician. Access to the page is **PASSWORD** protected.

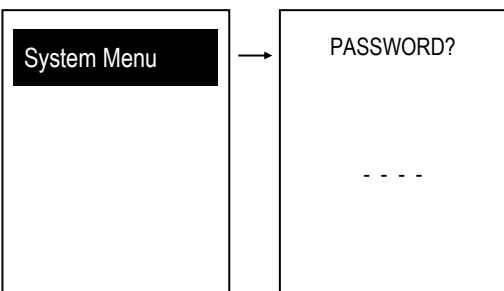

-WIFI CONFIGURATION

To configure thermo-stoves equipped with a WiFi module, it is necessary to:download the 4HEAT application, register your credentials and wait for the confirmation emails. Then start the application and follow the set-up procedure step by step using the 4HEAT application. Once you have registered, you will see the following screen on your Smartphone (fig. A), select **WIKEY** and then configure it as in fig. B.



FIG.A

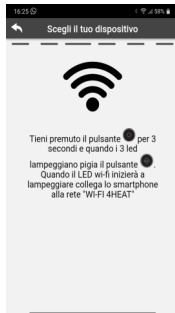

FIG.B

For more information on configuring the **WiKEY** module, see the dedicated manual using the following QR Code:



	Click	Press and hold
K1		Press for 3 seconds:Power On / Power Off / Reset Block
K2	Select the value to display (Combustion Power, Room Thermostat, Heating Power)	Press for 3 secondsAllows you to enter local WiFi network configuration mode (LEDs L7,L8,L9 flash).
K3	Modification of the selected value (LEDs L7, L8, L9 show the value).During the local Wifi configuration, start the configuration procedure	Press and holdReset the configuration.

- EMERGENCY CONTROL PANEL (AQUA) WIKEY

Emergency control panel with basic heating system functions with heating configured for Wi-Fi and Radio connections.



CHANGING A VALUE

Select the value to be changed by pressing K2. Press K3 to enter edit mode; the LED associated with the value will flash while LEDs L7, L8, L9 display the value. Press K3 again to change the value. The data is saved if no keys are pressed for 5 seconds or if you move onto the next value by pressing K2.

LED Value L7,L8,L9

LED value	0	Min	Average	Max	Auto (only for power levels)
L7	○	○	○	●	●
L8	○	○	●	●	●
L9	○	●	●	●	●

NOTE: The Minimum, Average and Maximum value of the local Room Thermostat can be set by the user via a 2WAYS+ device.

Changing the Heating Power

Press **K2** with a simple click and select the heating power **L4**. By pressing **K3** the LED **L4** flashes, by pressing **K3** again the LEDs **L7,L8, L9** start flashing simultaneously, to change the power level press **K3** again. By clicking again, it is possible to change the power according to the available values. **E.g.:** 1-2-3 (Minimum, Average, Maximum). After 3 seconds, the value is saved and the normal display reappears.

Changing the Room Thermostat Value

Press **K2** with a simple click and select the Local Room Thermostat **L5**. By pressing **K3** the LED **L5** flashes, by pressing **K3** again the LEDs **L7,L8, L9** start flashing simultaneously, to change the power level press **K3** again. By clicking again, it is possible to change the power according to the available values. **E.g.:** 1-2-3 (Minimum, Average, Maximum). After 3 seconds, the value is saved and the normal display reappears.

Changing the Combustion Power

Press **K2** with a simple click and select the combustion power **L6**. By pressing **K3** the LED **L6** flashes, by pressing **K3** again the LEDs **L7,L8, L9** start flashing simultaneously, to change the power level press **K3** again. By clicking again, it is possible to change the power according to the available values. **E.g.:** 1-2-3 (Minimum, Average, Maximum). After 3 seconds, the value is saved and the normal display reappears.

Led	Symbol	Description
L1		Multicolour LED: Blue: System off Green: System on Flashing green: System being turned On/Off Red alternating with the other two colours: System Error
L2		Service
L3		Fixed LED: Connected to the local Wifi network Flashing: Wifi configuration
L4		Displays Heating Power in the values of LEDs L7, L8, L9.
L5		Displays Local Room Thermostat in the values of LEDs L7, L8, L9.
L6		Displays Combustion Power in the values of LEDs L7, L8, L9.
L7 L8 L9		They display the selected values (Minimum, Average, Maximum)

ERROR LIST AND SOLUTIONS

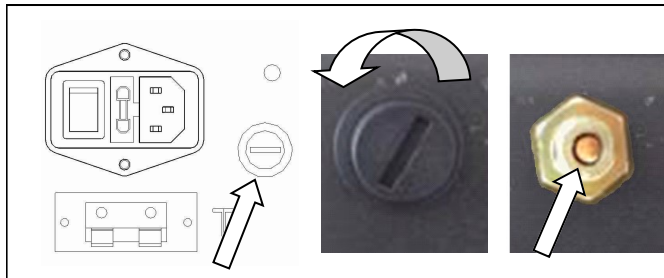
Code	Description	Cause	Operations to be performed	Solutions
Er01	Switch off through intervention of the safety thermostat with manual reset in error for high water temperature or high temperature in the pellet tank	PUMP BLOCKED OR BROKEN	Reset the thermostat, unblock and verify the proper function of the pump	If the pump is broken call an authorized technician
		AIR IN THE SYSTEM	Reset the thermostat, unblock and verify if there is any air in the system	Discharge the air from the system
		RESETTING THERMOSTAT BROKEN	Reset the thermostat, unblock and turn on the stove, if the error occurs <u>immediately</u> , it is likely that the thermostat is broken	If the error persists, call an authorised technician
		CONTROL UNIT BROKEN	Reset the thermostat, unblock and turn on the stove, if the error occurs <u>immediately</u> , it is likely that the control unit is broken	If the error persists, call an authorised technician
		HIGH TEMPERATURE IN PELLETTANK	Reset the thermostat, unblock and turn on the stove, if the error occurs turn off the stove	If the error persists, call an authorised technician
		 <p>To reset the thermostat and subsequently clear the error, remove the cylindrical plastic cap located near the power socket, unscrew it counterclockwise and press the button below.</p>		
Er02	Switch off due to chimney flue Occlusion, It can only intervene if the Exhaust Fan is active	CHIMNEY FLUE OCCLUDED	Unblock and check, if you need to clean your chimney flue	If the error persists, contact an authorised technician
		WIND IN THE CHIMNEY FLUE	Unblock and check if the flue needs to be installed according to standard regulations and directions contained in this manual	
		PRESSURE SWITCH BROKEN	Unblock and turn on the stove, if the error occurs immediately, it is likely that the pressure switch is broken	
		CONTROL UNIT BROKEN	Unblock and turn on the stove, if the error occurs immediately, it is likely that the control unit is broken	
Er03	Turn off due to low fume temperature	PELLET TANK EMPTY	Unblock and check if there are any pellets in the tank	Refill pellet tank
		BLOCKED AUGER	Unblock, clean burner and turn the stove on again	If the error persists, contact an authorised technician
		AUGER MOTOR BROKEN		
		EXHAUST FUME PROBE BROKEN		
Er04	Turn off due to high water temperature	PUMP BLOCKED OR BROKEN	Unblock and verify the proper function of the pump	If the pump is broken call an authorized technician
		AIR IN THE SYSTEM	Unblock, and verify if there is any air in the system	Discharge the air from the system
		UNDERSIZED HEATING SYSTEM	Unblock and verify if part of the system has been isolated	If the error persists, call an authorised technician
		BOILER PROBE BROKEN	Unblock and turn on the stove, if the error occurs <u>immediately</u> , it is likely that the boiler probe is broken	If the error persists, call an authorised technician
		CONTROL UNIT BROKEN	Unblock and turn on the stove, if the error occurs <u>immediately</u> , it is likely that the control unit is broken	If the error persists, call an authorised technician

Code	Description	Cause	Operations to be performed	Solutions
Er05	Turn off due to high fume temperature	DIRTY STOVE	Unblock and turn on the stove, if the error reoccurs, the stove probably needs to be cleaned	If the error persists, contact an authorised technician
		EXHAUST FUME SENSOR BROKEN	If the fume temperature is high even during the shutdown phase, thermocouple is broken	
Er07	Turn off due to Encoder error	NO SIGNAL TO ENCODER	Unblock and turn on the stove, if the error reoccurs, then the exhaust fan or control unit is broken	If the error persists, contact an authorised technician
Er08	Turn off due to Encoder error	NON SETTING ENCODER	Unblock and turn on the stove, if the error reoccurs, then the exhaust fan or control unit is broken	
Er09	Turn off due to low pressure in the system	LOW PRESSURE IN THE SYSTEM	Check the pressure of the heating system	Refill the system with water
		PRESSURE SENSOR BROKEN	Check the pressure in the system and refill. If after refilling, the pressure is still low then the pressure sensor is broken	If the error persists, contact an authorised technician
Er10	Switch off due to high pressure in the system	HIGH PRESSURE IN THE SYSTEM	Check the pressure of the heating system	Discharge water from the system , for example from a radiator
		PRESSURE SENSOR BROKEN	Check the pressure in the system and discharge. If after emptying the system the pressure is still high then the pressure sensor is broken	If the error persists, contact an authorised technician
Er11	The error occurs due to problems with the internal clock	CLOCK ERROR	Turn off the main switch, reset the time and date (page 11), then unblock. If the error persists, replace the battery on the control unit, reset the time and date, then unblock	If the error persists, contact an authorised technician
Er12	Ignition failure	EMPTY PELLET TANK	Unblock and check if there are any pellets in the tank	Refill pellet tank
		IGNITION RESISTANCE BROKEN	Unblock, clean the burner then turn on, if the following ignitions are not successful then the ignition resistance must be replaced	If the error persists, contact an authorised technician
		DIRTY BURNER	Unblock, clean burner then turn on again	Clean burner
Er15	Turn off due to power failure	BLACKOUT	Power failure	If the error persists, contact an authorised technician
Er16	Turn off due to RS485 communication error	TOUCH DISPLAY DOES NOT COMMUNICATE WITH THE CONTROL UNIT	Sbloccare e verificare se il display è correttamente collegato al cavo	If the error persists, contact an authorised technician
Er17	Turn off due to failed air flow regulation	MALFUNCTION OF THE FCS	Unblock and restart the boiler	If the error persists, contact an authorised technician
Er23	Turn off for Boiler Probe Return or Probe Puffer or Low Puffer Probe open	MALFUNCTION BY ONE OF THE PROBES	Unblock and restart the boiler	If the error persists, contact an authorised technician
Er25	Turn off due to anomaly in burner cleaning system	ANOMALY IN THE AUTOMATIC BURNER CLEANING SYSTEM	Unblock and check if there are obstructions that prevent the movement of the burner base during the cleaning phase	If the error persists, contact an authorised technician

Code	Description	Cause	Operations to be performed	Solutions
Er39	Turn off due to flowmeter error	FLOWMETER INCORRECTLY CONNECTED OR BROKEN	Unblock and turn on the stove	If the error persists, contact an authorised technician
Er41	Turn off due to minimum air flow in Check Up or in Normal and Modulation not achieved	FLOWMETER INCORRECTLY CONNECTED OR BROKEN	Unblock and turn on the stove	If the error persists, contact an authorised technician
Er42	Turn off due to maximum airflow exceeded	INCORRECT READING FROM PART OF FLOW METER	Unblock and turn on the stove	If the error persists, contact an authorised technician
Er44	Turn off because of open front door or open pellet door	FRONT DOOR OR PELLETT DOOR OPEN FOR MORE THAN 120 SECONDS	Unlock and check if the doors have been closed correctly	If the error persists, contact an authorised technician
Er47	Turn off due to lack of Auger Encoder signal	NO ENCODER SIGNAL	Unlock and turn on again, if the error recurs, the auger motor or control unit is broken	If the error persists, contact an authorised technician
Er48	Turn off due to unsuccessful speed regulation Auger Encoder	NON-REGULATING ENCODER	Unlock and turn on again, if the error recurs, the auger motor or control unit is broken	If the error persists, contact an authorised technician
PORT	Turn off due to open door	FRONT DOOR OR PELLETT DOOR OPEN	Check if the front door is closed correctly	If the error persists, contact an authorised technician
Service	Acoustic alarm	MESSAGE THAT INDICATES THE ACHIEVEMENT OF THE SCHEDULED FUNCTIONING HOURS	The stove needs a maintenance and cleaning procedure	If the error persists, contact an authorised technician
WIFI	WiFi !	WiFi disconnected		
CLEANING ON	Automatic cleaning start of brazier	Dirty brazier		

PLUMBING CONFIGURATION

It is possible to integrate the hydro stove to one of the following hydraulic system configurations considered most suitable. To set the configuration, an **authorized technician** must be contacted.

CONFIGURATION 0

The configuration show in the figure is set. This is the standard setting.

If the domestic hot water kit is installed, it is not necessary to change the setting on the hydro stove.

Connections on the control unit

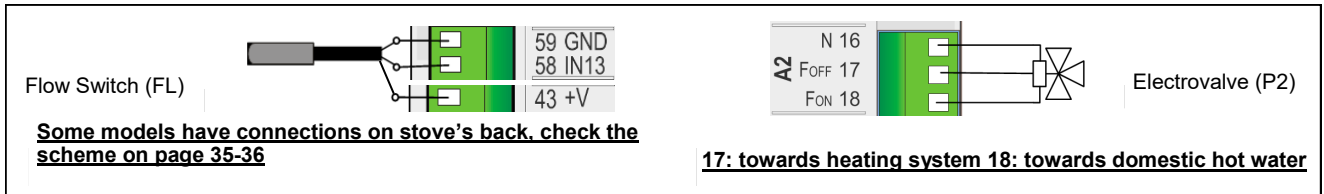

Connections on the heating system (the following figure is only illustrative)

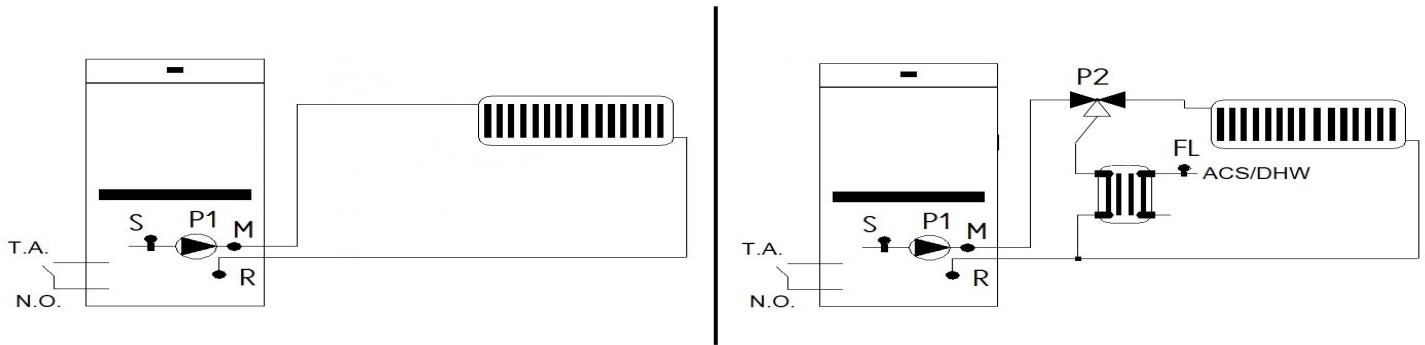

The system includes: the hydro stove Boiler Probe (**S1**), the hydro stove Pump (**P1**), Electrovalve of the kit (**P2**), Flow Switch of the kit (**FL**).

CONFIGURATION 2

The configuration shown in the figure is set.

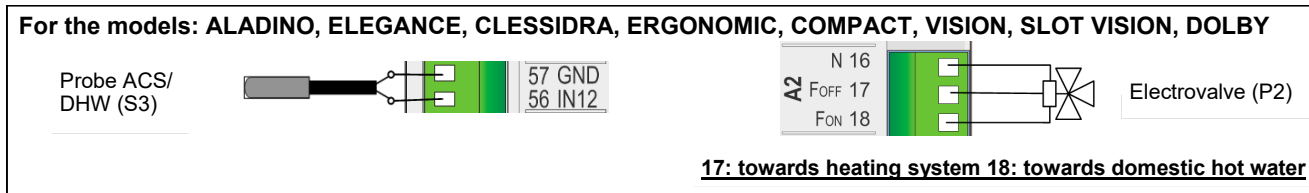
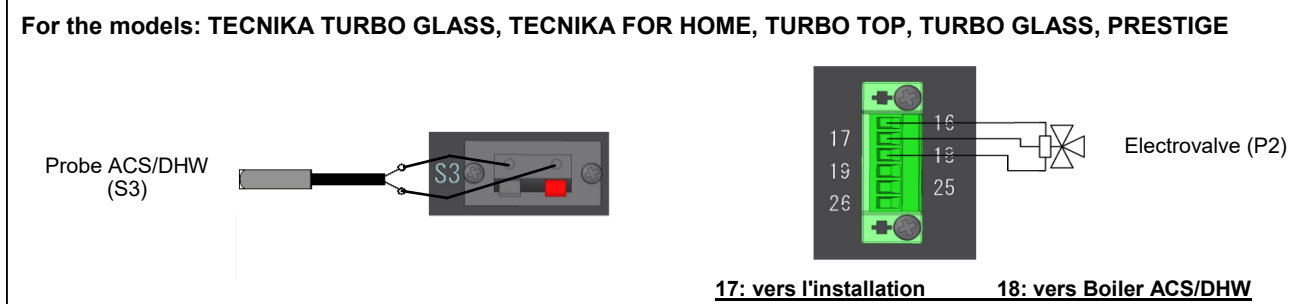
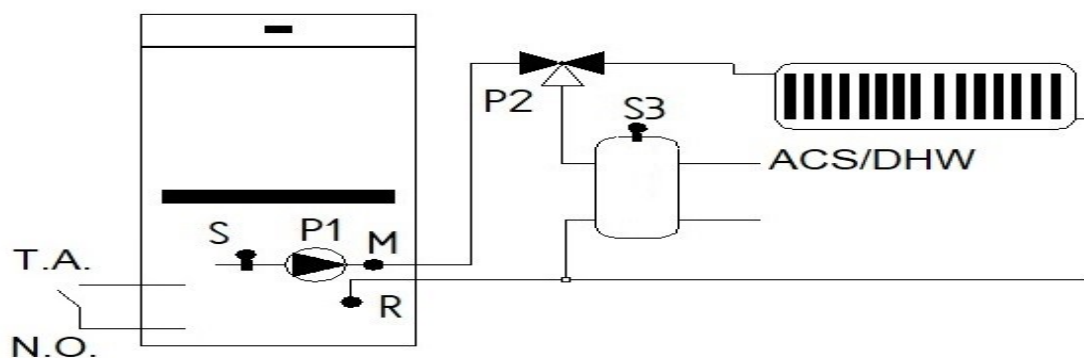
Connections on the control unit**Connections on stove's rear panel****Connections on the heating system (the following schematic is only illustrative)**

The system includes: the hydro stove Boiler Probe (S), the hydro stove Pump (P1), Valve (P2), Boiler/Puffer Probe (S3).

CONFIGURATION 4

The configuration shown in the figure is set.

Connections on the control unit

For models: ALADINO, ELEGANCE, CLESSIDRA, ERGONOMIC, COMPACT, VISION, SLOT VISION, DOLBY



Connections on stove's rear panel

For models: TECNIKA TURBO GLASS, TECNIKA FOR HOME, TURBO TOP, TURBO GLASS, PRESTIGE

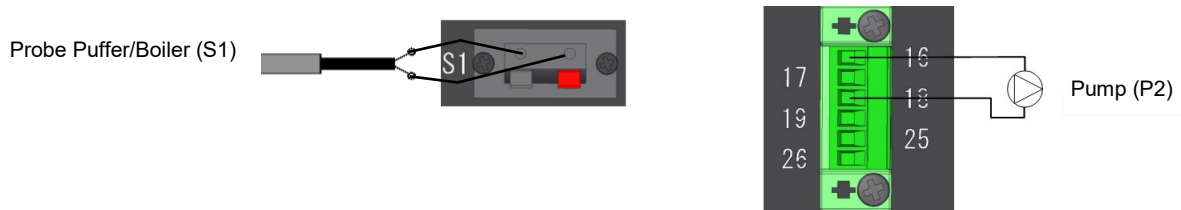

Connections on the heating system (the following schematic is only illustrative)

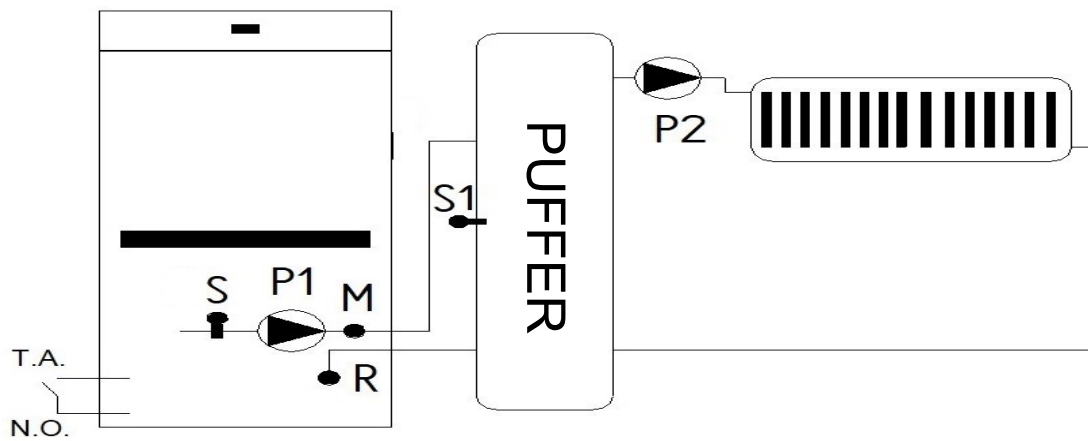

The system includes: the hydro stove Boiler Probe (S1), the hydro stove Pump (P1), Boiler/Puffer Probe (S1), the heating system pump.

CONFIGURATION 6

The configuration shown in the figure is set.

Connections on the control unit

For models: ALADINO, ELEGANCE, CLESSIDRA, ERGONOMIC, COMPACT, VISION, SLOT VISION, DOLBY

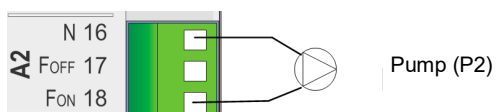
**Connections on stove's rear panel**

For models: TECNIKA TURBO GLASS, TECNIKA FOR HOME, TURBO TOP, TURBO GLASS, PRESTIGE

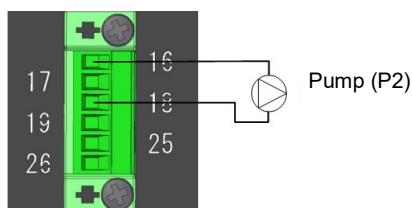
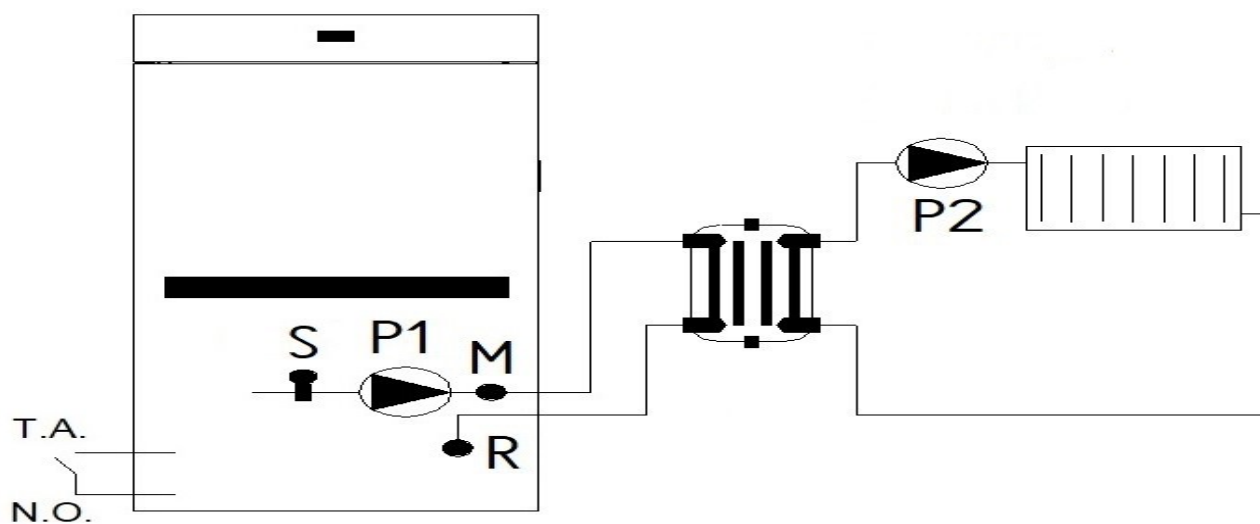
**Connections on the heating system** (the following schematic is only illustrative)

The system includes: the hydro stove Boiler Probe (**S1**), the hydro stove Pump (**P1**), Boiler/Puffer Probe (**S1**), the heating system pump.

CONFIGURATION 10

The configuration shown in the figure is set.

Connections on the control unit

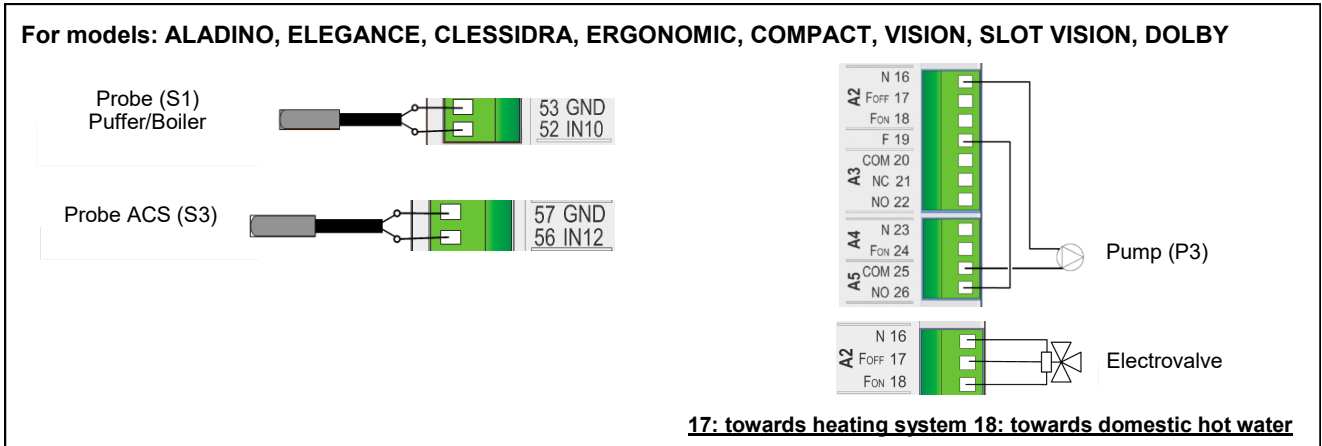

Connections on stove's rear panel

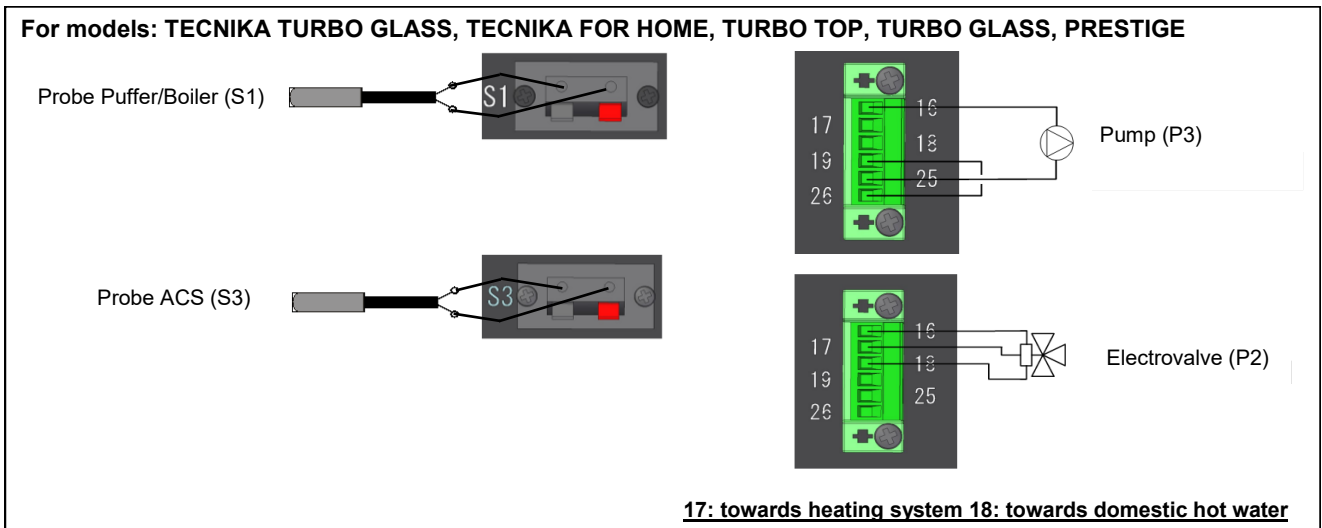

Connections on the heating system (the following schematic is only illustrative)

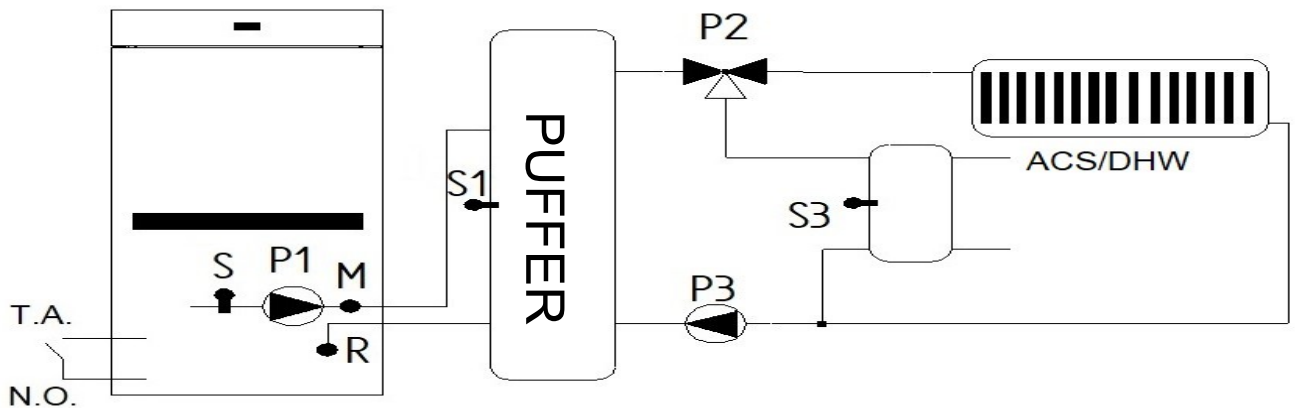

The system includes: the hydro stove Boiler Probe (S1), the hydro stove Pump (P1), heating system Pump (P3), Puffer Probe(S1),Electrovalve (P2), DHV probe (S3).

CONFIGURATION 11

The configuration shown in the figure is set.

Connections on the control unit

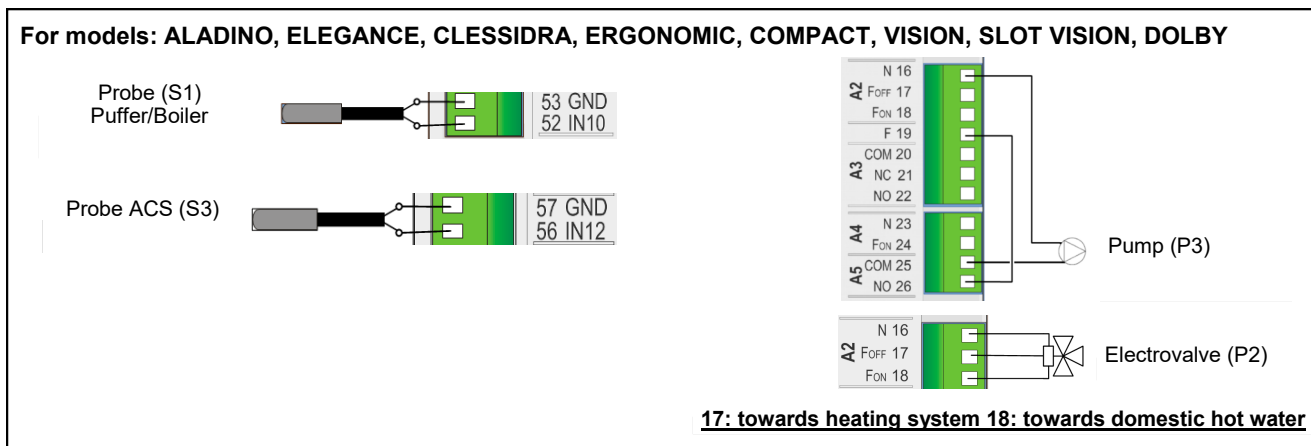

Connections on stove's rear panel

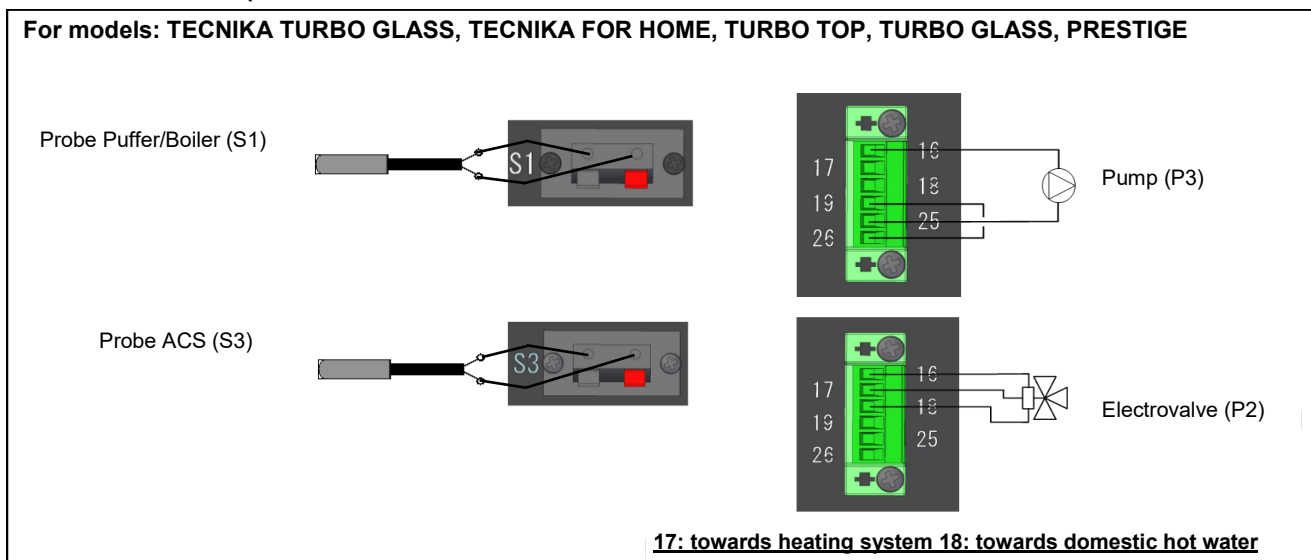

Connections on the heating system (the following schematic is only illustrative)

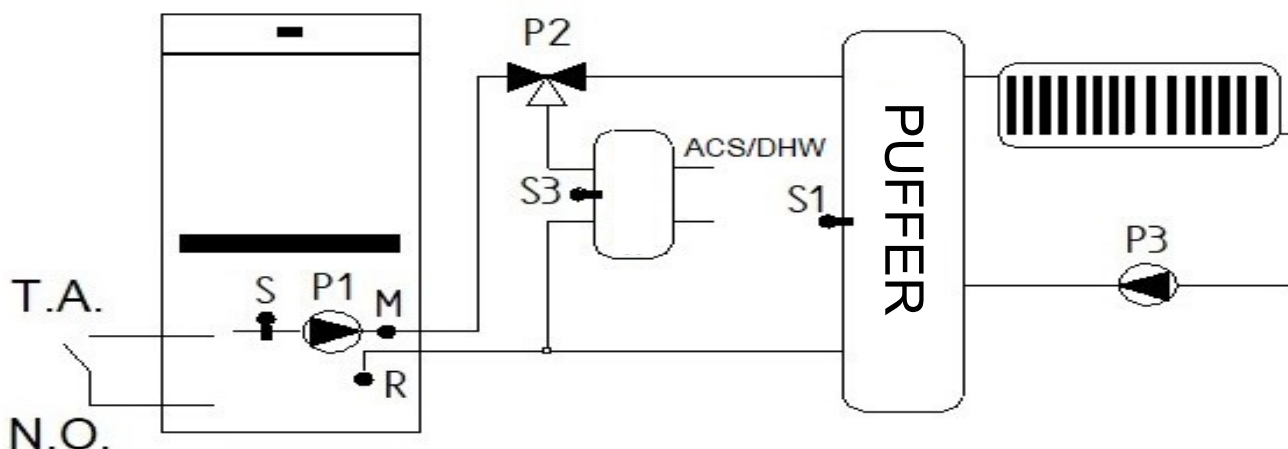

The system includes: the hydro stove Boiler Probe (S), the hydro stove Pump (P1), heating system Pump (P3), Puffer Probe(S1), Electrovalve (P2), DHV probe (S3).

ELECTRONIC CONTROL UNIT Code PSYSS04000003

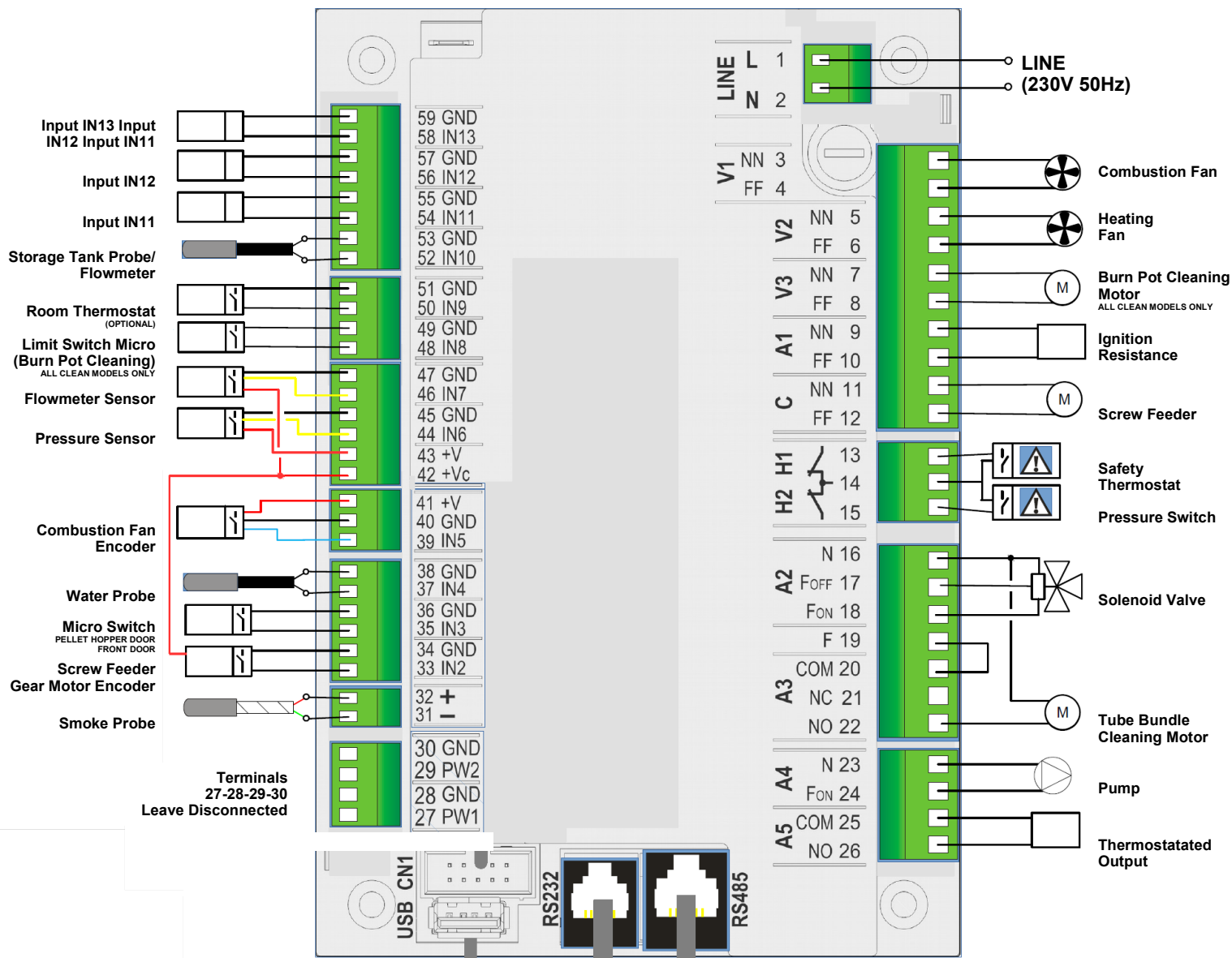

Remote control Code PSYSI04000005

USB Stick

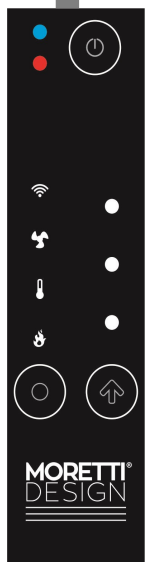

WIKey / For Aladino models with built-in WI-FI 4HEAT system Code PSYSF09000002

ELECTRONIC CONTROL UNIT Code PSYSS04000003

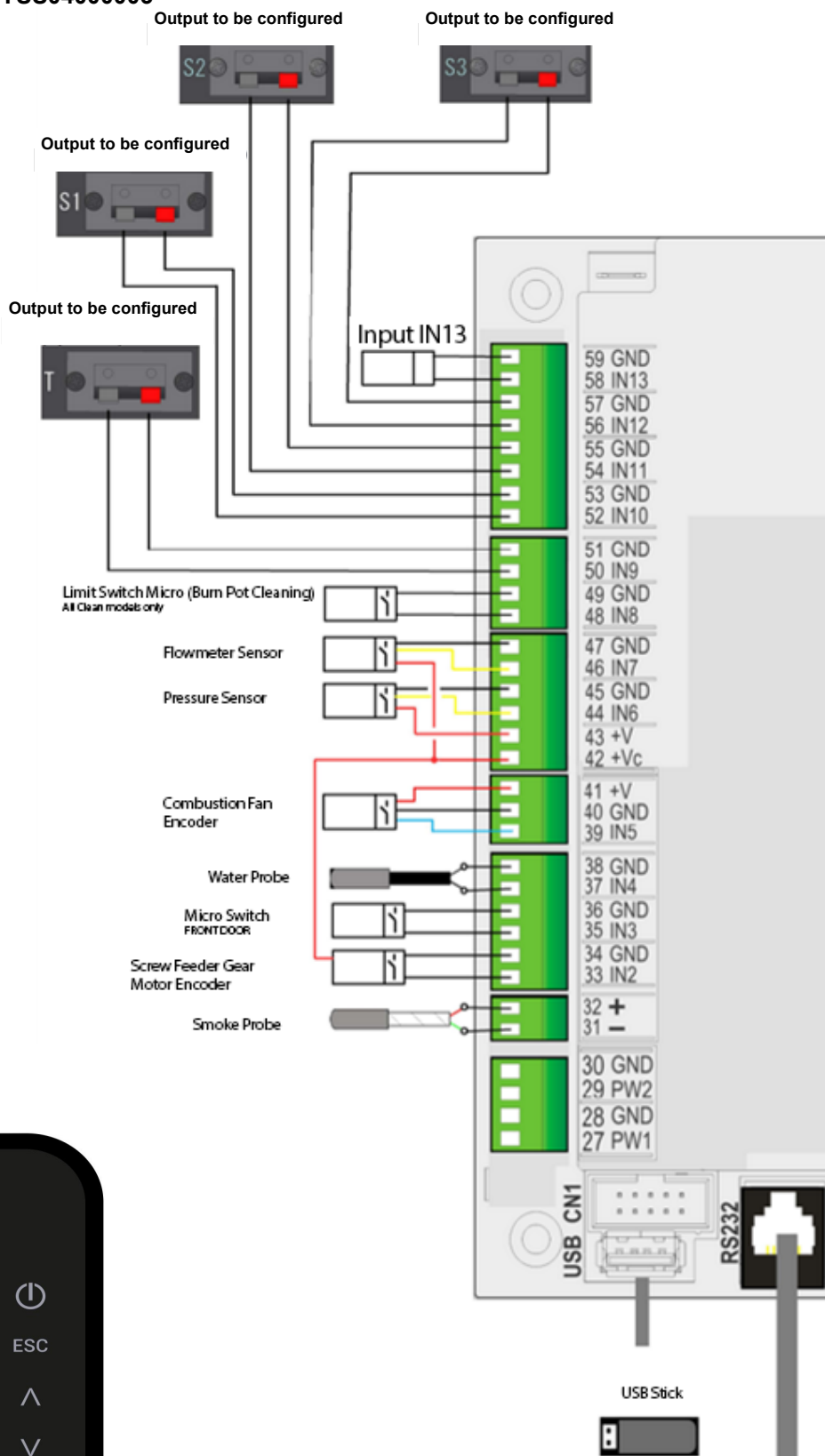

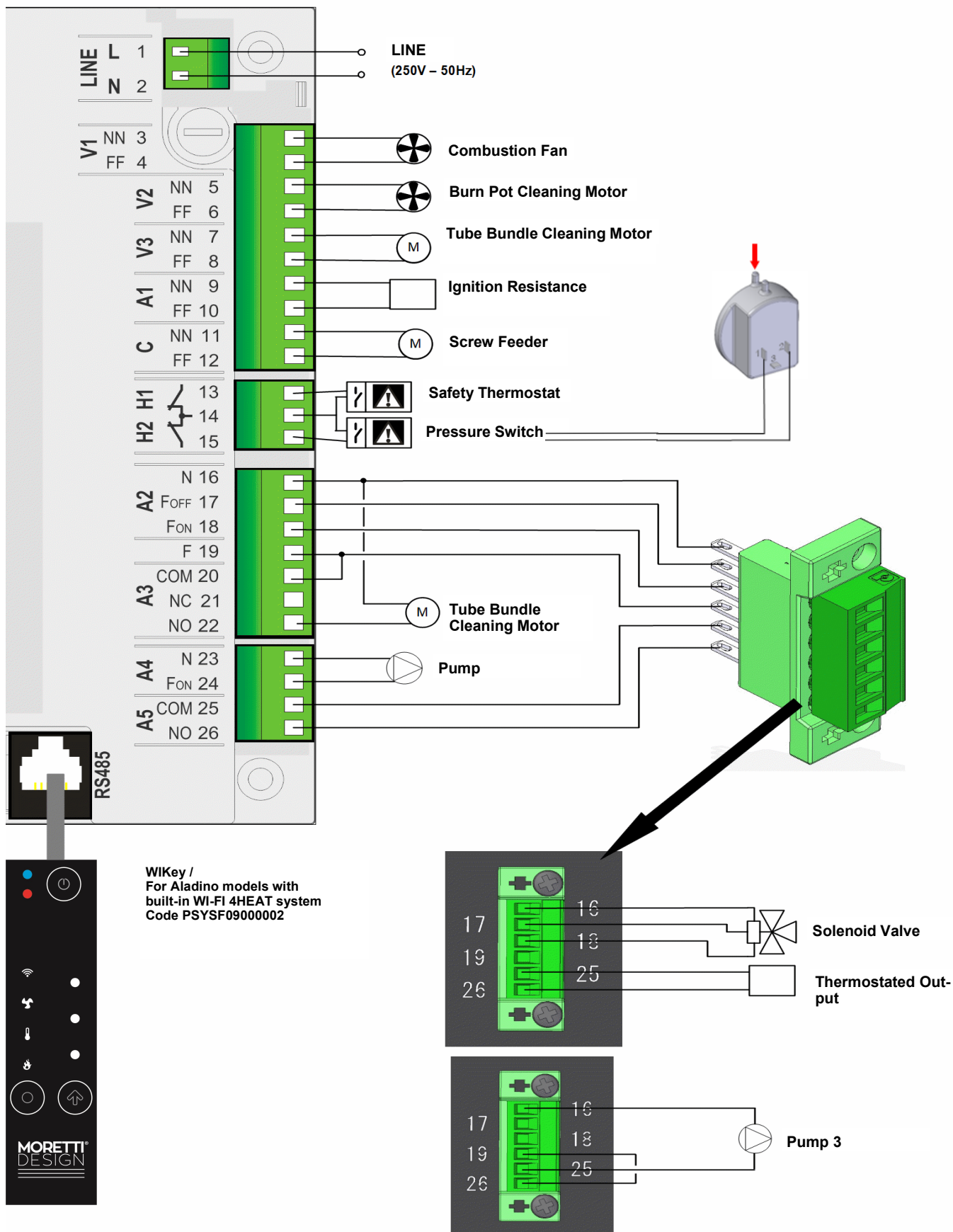

Pin		Function
1	L	Main Power Supply (250V - 50Hz)
2	N	
3	NN	Exhaust Fan
4	FF	
5	NN	Heating Fan
6	FF	
7	NN	Motor for Burner Cleaner <small>ONLY ALL CLEAN MODELS</small>
8	FF	
9	NN	Ignition Resistance
10	FF	
11	NN	Auger Motor
12	FF	
13		Pellet Tank Safety Thermostat
14		Safety Resetting Thermostat
15		Safety Pressure Switch
16	N	Electrovalve / Turbolator Cleaning Motor
17	F _{OFF}	
18	F _{ON}	
19	F	Electric bridge
20	COM	
21	NC	-
22	NO	Turbolator Cleaning Motor
23	N	
24	F _{ON}	Pump
25	COM	
26	NO	Thermostat Exit
27	PW1	
28	GND	-
29	PW2	-
30	GND	-
31	Verde -	Exhaust Probe
32	Rosso +	
33	IN2	Auger Motor Encoder
34	GND	
35	IN3	Micro Switch (Pellet door and Front door)
36	GND	
37	IN4	Water probe
38	GND	
39	IN5	Encoder Sensor Exhaust Ventilator
40	GND	
41	+V	Flowmeter Sensor / Auger Motor Encoder
42	+Vc	
43	+V	Pressure Sensor
44	IN6	
45	GND	Flowmeter Sensor
46	IN7	
47	GND	Micro limit Switch (Burner Cleaner) <small>ONLY ALL CLEAN MODELS</small>
48	IN8	
49	GND	Room Thermostat <small>(OPTIONAL)</small>
50	IN9	
51	GND	Puffer Probe/ Flowswitch
52	IN10	
53	GND	Input IN11
54	IN11	
55	GND	Input IN12
56	IN12	
57	GND	Input IN13
58	IN13	
59	GND	
USB		USB Connector
RS232		Serial connector / External wifi 4heat connection system
RS485		WiKey connector / For Aladino models with integrated Wifi 4Heat System
CN1		CP Series Command Panel connector

MAINTENANCE

Before performing any maintenance procedures on the stove, follow these precautions:

- Wait until all parts of the stove are cold.
- Wait until the ashes are completely off.
- Make sure that the switch is in the "0" position.
- Make sure that the power cable has been disconnected from the main power supply.

PLEASE FOLLOW CAREFULLY THE FOLLOWING CLEANING INSTRUCTIONS!

MORETTI DESIGN IS NOT RESPONSIBLE FOR DAMAGE TO PEOPLE, ANIMALS OR THINGS CAUSED BY A NON-COMPLIANCE OF THE FOLLOWING INDICATIONS.

In addition to the annual maintenance that must be carried out by authorized personnel, frequent cleaning procedures such as cleaning the burner, emptying the ash drawer and cleaning the tube bundle should be carried out.

Cleaning the burner

It is necessary to check if the burner is clean, that there are no combustion residuals or if the air ports are not obstructed. All this to avoid that the stove does not perform a poor combustion and to avoid overheating which could cause damage to the stove's painted surfaces or a failed ignition of the flame.

While the hydro stove is in operation, residues can form in the burner that must be removed before switching on again. The amount of ashes left over in the burner depends on the type of pellet used, even the same type of fuel from different bags of a the same brand can have different outcomes when burnt.

Automatic burner cleaner



The PLUS CLEAN models are equipped with an automatic burner cleaning system that activates during the first phase of the ignition of the hydro stove. This function can also be deactivated.

Emptying the ash drawer



The ash drawer is located inside the combustion chamber. To access it, open the door, pull the drawer out and then vacuum all ash deposits. For the PLUS CLEAN models, after consuming more than 80 bags of pellets, the drawer can be simply emptied once. The bottom inspection compartment should be opened at least once a month in order to vacuum all combustion residuals.

Cleaning the tube bundle (see dedicated manual)



The wiper can be accessed through the handle and moved according to the direction the arrows are pointing, repeat the movement at least four times. During the operation you will notice a small amount of dust/ash falling from the top of the combustion chamber. This operation must be performed weekly.

Automatic heat exchanger cleaning



Some models are equipped with an automatic heat exchanger cleaning system (AUTO CLEAN) that is activated during the first phase of the ignition of the hydro stove.

Cleaning the pellet tank

Monthly empty the pellet tank and vacuum all pellet dust residuals deposited at the bottom.

Cleaning the surfaces

Use a rag soaked with water for cleaning the painted metal surfaces. The use of detergents or aggressive diluents can damage the stove's surfaces.

To ensure that the hydro stove always has an optimal combustion and to avoid malfunctions, frequent cleaning operations must be carried out. The frequency of these operations may vary according to the time of use of the stove and quality of the pellets.

To avoid the water from freezing in the plumbing system, it is recommended to not disconnect the electrical power from the hydro stove, if the water temperature drops to 5 °C, it automatically activates the pump to prevent freezing.

An overall accurate maintenance check up of the stove must be carried out annually, and this must be performed by a qualified technician. The stove must be kept in such a way as to preserve conditions that ensure safety and efficiency.

WARRANTY

Warranty certification

Thanking you for choosing our product, MORETTI DESIGN invites you to consult the user manual and to read the following warranty conditions. The manufacturer provides the customer with a 24 month period warranty over the product, that starts from the date of purchase.

Warranty conditions

The warranty is limited and only covers manufacturing defects.

Components not covered by warranty:

- Ceramic glass
- Door seals
- Paint
- Handles
- Knobs
- Majolica coating
- Metal coating
- Ignition resistance*
- Fuses
- Combustion chamber parts
- Wearing parts
- The burner

*The ignition resistance is covered by a **6-month warranty from the date of purchase of the product on which it is installed**, provided that the first start-up and commissioning have been carried out by a qualified technician.

The warranty does not cover damage caused by:

No first ignition and testing procedure carried out by a qualified technical assistance centre (**expense on the client's behalf**).

Installation performed by non professional personnel and not in compliance with standard regulations or used in a different manner than that it was designed for.

Electrical overloads caused by lightning or non conformed electrical sockets.

Transport and tampering by unauthorized personnel.

The non application at least once a year of cleaning and routine maintenance procedures of the product by a qualified authorized service (**expense on the client's behalf**).

The use of cheap/poor quality fuel or any other material that can damage the product.

Any damage caused by an improper installation and/or disattention of the user.

The following interventions are not considered under warranty:

Interventions to adjust combustion parameters.

Interventions to repair damaged parts caused by poor maintenance.

EXCLUSION OF LIABILITY

Failure to comply with the operating conditions and decadence of the warranty will result in the exclusion of the manufacturer from all liability for any damage to the customer to animals and other people.

MORETTI DESIGN

Moretti Fire s.r.l.
ITALY
www.morettidesign.it

The Moretti fire s.r.l. assumes no responsibility for any errors in this manual and the right to modify without notice features of its products